



Ground Vehicle Standard for Ambulances

v.1.0 Edition

Established and Maintained by CAAS

The Commission on Accreditation of Ambulance Services

Published Date: March 28, 2016

Effective Date: July 1, 2016

www.groundvehiclestandard.org

www.caas.org



Acknowledgements

The following groups & individuals participated as the Steering Committee for the GVS v.1.0:

PROJECT TEAM

Commission on Accreditation of Ambulance Services (CAAS)

Mark Meijer (*Chair, CAAS*)
Mark Postma (*Vice Chair, CAAS; GVS v.1.0 Project Co-Chair*)
Joe Penner
Dale Berry (*Alternate*)
Sarah McEntee, EMT-P (*Executive Director*)
Marcie McGlynn (*Staff*)

Association and Society Management International (ASMI)

Ian Weston, MPP, QAS, EMT (*GVS v.1.0 Project Manager*)

ORGANIZATIONAL STAKEHOLDER LIAISONS

Ambulance Manufacturers Division (AMD)

Mark Van Arnam (*GVS v.1.0 Project Co-Chair*)
Alain Brunelle (*Alternate*)

American Ambulance Association (AAA)

Ron Thackery, JD
Mike Hall (*Alternate*)

American College of Emergency Physicians (ACEP)

Sabina Braithwaite, MD, MPH, NREMT-P

Association of Air Medical Services (AAMS)

Rick Sherlock
Elena Sierra (*Alternate*)

National Association of EMS Physicians (NAEMSP)

Brent Myers, MD, MPH
Lynn White, MS (*Alternate*)

National Association of EMTs (NAEMT)

Skip Kirkwood, MS, JD, EMT-P, EFO, CEMSO
Don Lundy, BHS, NREMT-P (*Alternate*)

National Association of State EMS Officials (NASEMSO)

Michael Berg, BS, NRP
Dia Gainor (*Alternate*)

National EMS Management Association (NEMSMA)

Aarron Reinert, BA, NREMT-P
Troy Hagen, MBA (*Alternate*)

National Volunteer Fire Council (NVFC)

Ken Knipper
Joe Maruca (*Alternate*)

Transportation Research Board (TRB)

Bernardo Kleiner

GOVERNMENT AGENCY LIAISONS (NON-VOTING)

U.S. Department of Homeland Security (DHS)

Richard Patrick, MS, CFO, EMT-P
Paul Brooks (*Alternate*)
Eric Chaney (*Alternate*)
James Grove (*Alternate*)

National Highway Traffic Safety Administration (NHTSA)

Drew Dawson
Dave Bryson (*Alternate*)

National Institute for Occupational Safety & Health (NIOSH)

Jim Green

National Institute of Standards and Technology (NIST)

Jennifer Marshall
Allison Barnard Feeney (*Alternate*)

U.S. Department of Health & Human Services (HHS)

Kevin Horahan, JD, MPH, EMT-P
Gregg Margolis, PhD, NREMT-P (*Alternate*)

U.S. General Services Administration (GSA)

John McDonald



ABBREVIATIONS, TERMS & ACRONYMS USED IN THIS DOCUMENT

AAA	American Ambulance Association	GXL	Thin wall automotive wire
AAMS	Association of Air Medical Services	HHS	U.S. Department of Health & Human Services
AC	Alternating current	IAFC	International Association of Fire Chiefs
ACEP	American College of Emergency Physicians	ILAC	International Laboratory Accreditation Cooperation
AD	Additional duty	KKK-A	Federal Specification for the Star-of-Life Ambulance
AMD	Ambulance Manufacturers Division	MIL	Military
AMECA	Automotive Manufacturers Equipment Compliance Agency	MRA	Mutual Recognition Arrangement
ANSI	American National Standards Institute	NACLA	National Cooperation for Laboratory Accreditation
ASMI	Association and Society Management International	NAEMSP	National Association of EMS Physicians
ASTM	American Society For Testing And Materials	NAEMT	National Association of EMTs
AVSC	Automatic vehicle stability control	NAEMSO	National Association of State EMS Officials
CAAS	Commission on the Accreditation of Ambulance Services	NEC	National Electrical Code
CARB	Center for Advanced Research in Biotechnology	NEMA	National Electrical Manufacturers Association
CFR	Code of Federal Regulations	NEMSMA	National EMS Management Association
CG	Center of gravity	NFPA	National Fire Protection Association
DC	Direct current	NHTSA	National Highway Traffic Safety Administration
DHS	U.S. Department of Homeland Security	NIOSH	National Institute for Occupational Safety & Health
DOT	U.S. Department of Transportation	NIST	National Institute of Standards and Technology
EMSC	Emergency Medical Services For Children Program	NTEA	National Truck Equipment Association
EMSP	Emergency medical service provider	NVFC	National Volunteer Fire Council
EPA	U.S. Environmental Protection Agency	OEM	Original Equipment Manufacturer
EPDM	Ethylene propylene terpolymer rubber	OSHA	Occupational Safety and Health Administration
FCC	Federal Communications Commission	RF	Radio frequency
FMCSR	Federal Motor Carrier Safety Regulations	RPM	Revolutions per minute
FMVSS	Federal Motor Vehicle Safety Standards	SAE	Society Of Automotive Engineers
FSAM	Final stage ambulance manufacturer	SXL	Standard wall automotive wire
GAWR	Gross axle weight rating	TRB	Transportation Research Board
GSA	U.S. General Services Administration	USP	United States Pharmacopeial Convention
GVS	Ground Vehicle Standard		
GVWR	Gross vehicle weight rating		

TABLE OF CONTENTS

SECTION A - SCOPE, PURPOSE, CLASSIFICATION AND DEFINITIONS	4
SECTION B - APPLICABLE DOCUMENTS	6
SECTION C - REQUIREMENTS	9
C.1 GENERAL VEHICULAR DESIGN, TYPES, AND CONFIGURATION	9
C.2 VEHICLE, AMBULANCE COMPONENTS, EQUIPMENT, AND ACCESSORIES	9
C.3 RECOVERED MATERIALS	9
C.4 VEHICLE OPERATION, PERFORMANCE, AND PHYSICAL CHARACTERISTICS	10
C.5 VEHICLE WEIGHT RATINGS AND PAYLOAD	11
C.6 CHASSIS, POWER UNIT, AND COMPONENTS	12
C.7 ELECTRICAL SYSTEM AND COMPONENTS	15
C.8 LIGHTING, EXTERIOR AND INTERIOR	22
C.9 CAB-BODY DRIVER COMPARTMENT AND EQUIPMENT	25
C.10 AMBULANCE BODY AND PATIENT AREA	27
C.11 STORAGE COMPARTMENTS	31
C.12 OXYGEN, MAIN SUPPLY AND INSTALLATION AND SUCTION	33
C.13 ENVIRONMENTAL: CLIMATIC AND NOISE PARAMETERS	35
C.14 COMMUNICATIONS	36
C.15 ADDITIONAL SYSTEMS, EQUIPMENT, ACCESSORIES, AND SUPPLIES	36
C.16 PAINTING, COLOR, AND MARKINGS	37
C.17 MARKINGS, AND CAUTION AND IDENTIFICATION PLATES	37
C.18 MANUALS AND HANDBOOK OF INSTRUCTION	37
C.19 WORKMANSHIP STANDARD	38
SECTION D - CAAS GVS COMPLIANCE CERTIFICATION REQUIREMENTS	39
D.1 QUALIFYING PROVISIONS	39
D.2 DOCUMENTATION OF "CAAS GVS v.1.0" COMPLIANCE CERTIFICATION	39
D.3 CRITERIA OF CERTIFICATIONS	39
D.4 CERTIFICATION LETTER FORMAT	40
D.5 CERTIFICATION VERIFICATION DATA REPORTS	40
D.6 TESTS	40
SECTION E - CHANGES AND AMENDMENTS	41
E.1 CHANGES AND AMENDMENTS	41
E.2 GENERAL INQUIRIES – REQUEST FOR INTERPRETATION	41
E.3 PROCESS FOR REVISION	41
APPENDIX 1 - FIGURES	42
APPENDIX 2 - BUYERS GUIDE	47

SECTION A - SCOPE, PURPOSE, CLASSIFICATION AND DEFINITIONS

A.1 SCOPE

This Standard identifies the minimum requirements for new automotive Emergency Medical Services (EMS) ground ambulances built on Original Equipment Manufacturer's Chassis (OEM) that are prepared by the OEM for use as an ambulance. This Standard applies to new vehicles only.

The Standards referenced in GVS v.1.0 do not apply to the following vehicle categories:

1. Military Vehicles/Combat Support Ambulances
2. Stretcher Vans/Wheel Chair Vans/Transport Vehicles
3. Mass-Casualty Vehicles/Ambulance Buses
4. Refurbished or Remounted Ambulance
5. Fire Suppression Apparatus

APPENDIX 2 of this standard contains:

1. Optional configurations.
2. A worksheet to assist the purchaser in developing their procurement requirements.

A.2 PURPOSE

The object of CAAS, this document, and ambulance standard is to best serve patients by providing ground ambulances that are safe, nationally recognized, properly constructed, easily maintained, and, when professionally staffed and provisioned, will function reliably in pre-hospital or other mobile emergency medical service. The purpose of this document is to identify the standards for ground ambulances that are authorized to display the "CAAS GVS" symbol. It establishes minimum requirements, performance parameters and essential criteria for the design of ground ambulances in an effort to provide a practical degree of standardization and for the safety, comfort, and avoidance of aggravation of the patient's injury or illness.

A.3 "CAAS GVS" CERTIFICATION

The final stage ambulance manufacturer (FSAM) shall furnish to a purchaser an authenticated certification and label stating that the ambulance and equipment comply with the current standard in effect on the date the ambulance is contracted for. FSAMs making this certification are permitted to use the "CAAS GVS" symbol to identify an ambulance as compliant with the CAAS standards for ambulances. Use of the symbol must be in accordance with the purpose and use criteria set forth in these published guidelines by the Commission on Accreditation of Ambulance Services.

A.4 DEFINITIONS

A.4.1 DEFINITION OF GROUND AMBULANCE

The ambulance is defined as a vehicle used for emergency medical care that consists of:

1. A driver's cab compartment.
2. A patient compartment to accommodate an emergency medical services provider (EMSP) and a minimum of one patient located on the primary cot so positioned that the patient(s) can receive appropriate medical care during transit.
3. Accommodation for storage of equipment and supplies for emergency care at the scene as well as during transport.
4. Accommodation for installation of communication systems.



5. Audible and Visual Traffic warning devices.

A.4.2 DEFINITION OF ADDITIONAL CONSIDERATIONS

Additional Considerations located throughout this document. These boxes contain recommendations that currently exceed or enhance the existing standard to address specific needs or future innovations at the individual purchaser preference. Some local and state requirements may supersede these requirements.

A.4.3 RECOVERED MATERIALS

The term “recovered materials” means materials that have been collected or recovered from solid waste and reprocessed to become a source of raw materials, as opposed to virgin raw materials.



SECTION B - APPLICABLE DOCUMENTS

B.1 THE FOLLOWING STANDARDS AND REGULATIONS FORM A PART OF THIS STANDARD, TO THE EXTENT SPECIFIED OR REQUIRED BY LAW. UNLESS A SPECIFIC ISSUE OF A STANDARD OR REGULATION IS IDENTIFIED, THE ISSUE IN EFFECT, ON THE DATE THE AMBULANCE IS CONTRACTED FOR, SHALL APPLY.

Military Standards:

MIL-STD-461 Requirements for the Control of Electromagnetic Interference Characteristics of Subsystems and Equipment.

LAWS AND REGULATIONS:

29 CFR 1910.7 Definition and Requirements for a Nationally Recognized Testing Laboratory
40 CFR 86 Control of Air Pollution from New Motor Vehicles and New Motor Vehicle Engines
47 CFR, PART 90 Public Safety Radio Services (FCC)
49 CFR 571 Federal Motor Vehicle Safety Standards (FMVSS)
29 CFR 1910.95 Occupational Noise Exposure

ISO STANDARDS:

ISO/IEC 17025 General requirements for the competence of testing and calibration laboratories

National Truck Equipment Association / Ambulance Manufacturers Division (AMD):

AMD Standard 001 Ambulance Body Structure Static Load Test
AMD Standard 004 Litter Retention System
AMD Standard 005 12-volt DC Electrical System Test
AMD Standard 006 Patient Compartment Sound Level Test
AMD Standard 007 Patient Compartment Carbon Monoxide Level Test
AMD Standard 008 Patient Compartment Grab Rail Static Load Test
AMD Standard 009 125v AC Electrical Systems Test
AMD Standard 010 Water Spray Test
AMD Standard 011 Equipment Temperature Test
AMD Standard 012 Interior Climate Control Test
AMD Standard 013 Weight Distribution Guidelines
AMD Standard 014 Engine Cooling System Test
AMD Standard 015 Ambulance Main Oxygen System Test
AMD Standard 016 Patient Compartment Lighting Level Test
AMD Standard 017 Road Test
AMD Standard 018 Rear Step and Bumper Static Load Test
AMD Standard 019 Measuring Guidelines: Cabinets & Compartments
AMD Standard 020 Floor Distributed Load Test
AMD Standard 021 Aspirator System Test, Primary Patient
AMD Standard 022 Cold Engine Start Test
AMD Standard 023 Siren Performance Test
AMD Standard 024 Perimeter Illumination Test
AMD Standard 025 Measuring Guidelines: Occupant Head Clearance Zones



Society Of Automotive Engineers (SAE) International, Standards, And Recommended Practices:

- J163 Low Tension Wiring and Cable Terminals and Splice Clips
- J551 Performance Levels and Methods of Measurement of Electromagnetic Compatibility of Vehicles, Boats, and Machines
- J553 Circuit Breakers
- J561 Electrical Terminals, Eyelet, and Spade Type
- J575 Tests for Motor Vehicle Lighting Devices & Components
- J576 Plastic Materials, For Use In Optical Parts Such As Lenses and Reflectors of Motor Vehicle Lighting Devices
- J578 Color Specification for Electric Signal Lighting Devices
- J683 Tire Chain Clearance
- J845 Optical Warning Devices for Authorized Emergency, Maintenance, and Services Vehicles
- J928 Electrical Terminals, Pin, and Receptacle Type
- J1100 Motor Vehicle Dimensions
- J1128 Low Voltage Primary Cable
- J2498 Minimum Performance of the Warning Light System Used on Emergency Vehicles
- J3026 Ambulance Patient Compartment Seating Integrity and Occupant Restraint
- J3027 Ambulance Litter Integrity, Retention, and Patient Restraint
- J3043 Ambulance Equipment Mount Device or Systems

National Fire Protection Association (NFPA)

- 1901 Standard for Automotive Fire Apparatus
- 70 National Electric Code

American Society For Testing And Materials (ASTM) Standards:

- B117 Standard Practice for Operating Salt Spray (Fog) Apparatus IPC-610D Acceptability of Electronic Assemblies

B.2 OTHER PUBLICATIONS

The following documents are useful references. Unless a specific issue is identified, the issue in effect, on the date the ambulance is contracted for, shall apply.

Federal Standards:

- RR-C-901C Cylinders, Compressed Gas: High Pressure, Steel DOT 3aa And Aluminum Applications
- Standard No. 297 Rustproofing of Commercial (Non-tactical) Vehicles
- MIL-STD-1223 Non-tactical Wheeled Vehicles, Painting, Identification Marking, and Data Plate Standards.
- 29 CFR 1910.1030 Bloodborne Pathogens
- 21 CFR 820 Quality System Regulation

Society Of Automotive Engineers, International, Standards, And Recommended Practices:

- J537 Storage Batteries
- J541 Voltage Drop for Starting Motor Circuits



- J595 Flashing Warning Lamps for Authorized Emergency, Maintenance, and Service Vehicles
- J638 Test Procedure and Ratings for Hot Water Heaters for Motor Vehicles
- J639 Safety Practices for Mechanical Vapor Compression Refrigeration Equipment or Systems Used To Cool Passenger Compartment of Motor Vehicles
- J682 Rear Wheel Splash and Stone Throw Protection
- J858 Electrical Terminals, Blade Type
- J994 Backup Alarms, Performance Test and Application
- J1054 Warning Lamp, Alternating Flashers
- J1127 Battery Cable
- J1292 Automobile, Truck, Truck-Tractor, Trailer, and Motor Coach Wiring
- J1349 Engine Power Test Code, Spark Ignition and Diesel
- J1318 Strobe Warning Lights

American College Of Emergency Physicians (ACEP):
Guidelines for Ambulance Equipment

American National Standards Institute (ANSI):
Z535.1 American National Standard for Safety Colors

American Society For Testing And Materials Standards:
F 920 Standard Specification for Minimum Performance and Safety Requirements for Resuscitators Intended for Use with Humans
F 960 Standard Specification for Medical and Surgical Suction and Drainage Systems
D 4956 Standard Specification for Retroreflective Sheeting for Traffic Control
D6210 Standard Specification for Fully-Formulated Glycol Base Engine Coolant for Heavy-Duty Engines

Automotive Manufacturers Equipment Compliance Agency (AMECA):
Approval of Motor Vehicle Safety Equipment (*emergency lights and sirens*)

National Emergency Medical Services For Children (EMSC) National Resource Center (NRC):
Committee On Ambulance Equipment And Supplies
Guidelines for Pediatric Equipment and Supplies for Basic and Advanced Life Support Ambulances

Tire and Rim Association
2015-Year Book

B.3 ORDER OF PRECEDENCE

In the event of a conflict between the text of this standard and the references cited, the text of this standard shall take precedence.



SECTION C - REQUIREMENTS

C.1 GENERAL VEHICULAR DESIGN, TYPES, AND CONFIGURATION

C.1.1 DESIGN

The ambulance and equipment furnished under this standard shall be the OEM's untitled commercial vehicle of the Type and Configuration specified. The ambulance shall be complete with the operating accessories, as specified by the purchaser. The design of the vehicle and the specified equipment shall permit accessibility for servicing, replacement, and adjustment of component parts and accessories with minimum disturbance to other components and systems. The term "heavy-duty," as used to describe an item, shall mean in excess of the standard quantity, quality, or capacity and represents the best, most durable, strongest, etc., part, component, system, etc., that is commercially available on the OEM chassis.

C.1.2 TYPE I AMBULANCE (10,001 TO 14,000 Gross Vehicle Weight Rating (GVWR))
Type I vehicle shall be a cab chassis furnished with a modular ambulance body.

C.1.2.1 TYPE I-AD (ADDITIONAL DUTY) AMBULANCE (14,001 GVWR OR MORE)
Type I-AD shall be a Cab-Chassis with modular ambulance body, increased GVWR, storage, and payload.

C.1.3 TYPE II AMBULANCE (8,501 – 10,000 GVWR)
Type II ambulance shall be a chassis, with Integrated cab-body.

C.1.4 TYPE III AMBULANCE (10,001 TO 14,000 GVWR)
Type III shall be a Cutaway Van with modular ambulance body.

C.1.4.1 TYPE III-AD AMBULANCE (14,001 GVWR OR MORE)
Type III-AD shall be a Cutaway Van with modular body, and increased GVWR, storage, and payload.

C.1.5 CONFIGURATION OF PATIENT COMPARTMENT
The primary cot shall be mounted to provide maximum access from the EMSP seat.

C.2 VEHICLE, AMBULANCE COMPONENTS, EQUIPMENT, AND ACCESSORIES

The ambulance's chassis, cab, patient compartment, and accessories supplied by the FSAM, shall be standard commercial products, tested and certified to meet or exceed the requirements of this Standard. The ambulance shall comply with all Federal Motor Vehicle Safety Standards and other applicable Federal and state regulations specified for the year of manufacture. The chassis, components, and optional items shall be as represented in the OEM's current technical data. The ambulance body, equipment, and accessories shall be as represented in their respective FSAM's current technical data.

C.3 RECOVERED MATERIALS

All equipment, material, and articles required under this standard are to be new or fabricated from new materials not produced from recovered materials. None of these materials shall be interpreted to mean that the use of used or rebuilt products is allowed.



C.4 VEHICLE OPERATION, PERFORMANCE, AND PHYSICAL CHARACTERISTICS

All requirements in Section C.4 shall be met with the ambulance loaded at curb weight plus total usable payload.

C.4.1 TEMPERATURE CONDITIONS

The vehicle shall be capable of operating safely and efficiently, according to AMD Standard 011 (*Equipment Temperature Test*) and under the following environmental conditions:

C.4.1.1 ENVIRONMENTAL CONDITIONS

The ambulance shall be tested to operate at a minimum ambient temperature range from 0°F to 95°F.

C.4.2 NOISE AND SOUND LEVEL LIMITS, EXTERIOR

Unless more stringent sound levels are regulated by the states and municipalities where the ambulance will be based, the exterior noise level produced by the vehicle, except siren, shall not exceed Federal regulations.

C.4.3 VEHICLE PERFORMANCE

The ambulance shall provide a smooth, stable ride. When available from the OEM, automatic vehicle stability control (AVSC) shall be furnished. The completed ambulance shall conform to AMD Standard 017 (*Road Test*).

C.4.4 SPEED

The vehicles shall be capable of a sustained speed of not less than 65 mph over dry, hard surfaced, level roads, at sea level, and passing speeds of not less than 70 mph when tested in accordance with AMD Standard 017.

C.4.5 ACCELERATION

Vehicle shall have a minimum average acceleration, at sea level, of 0-55 mph within 25 seconds. Test shall be performed in accordance with AMD Standard 017 (*Road Test*).

C.4.6 GRADEABILITY

The vehicle shall be capable of meeting the following performance requirements. The determination shall be made by actual test or OEM's certified computer prediction.

C.4.6.1 GRADEABILITY AT SPEED

Minimum gradeability at speed shall be 55 mph on a 3% (1.72°) grade.

C.4.6.2 MINIMUM LOW SPEED GRADEABILITY

The minimum low speed gradeability shall be 5 mph on a 35% (19.3°) grade.

C.4.7 FORDING

The vehicle shall be capable of three fordings, without water entering patient and equipment compartments while being driven through a minimum of 8" of water, at speeds of 5 mph, for a distance of at least 100', in accordance with AMD Standard 017 (*Road Test*).

C.4.8 VEHICLE PHYSICAL DIMENSIONAL REQUIREMENTS

The ambulance dimensions (length, width, height) must comply with all applicable local, state and



Federal regulations. Length, width, and height are defined by, and should be documented in the purchasing agreement:

LENGTH

Overall length of the ambulance (OAL) specified shall include bumpers, rear step and bumper guards.

WIDTH

The overall width of ambulance bodies shall exclude mirrors, lights, and other safety appurtenances.

HEIGHT

Overall height shall be when loaded to curb weight. This should include roof-mounted equipment, but excludes two-way radio antenna(s).

C.4.8.1 ANGLE OF APPROACH, RAMP BREAKOVER AND DEPARTURE

With the exception of the OEM’s furnished and installed components, the ambulance shall provide not less than the following clearance (in according with test procedure SAE J1100 (*Motor Vehicle Dimensions*”)):

- Approach angle 20°
- Ramp breakover 10°
- Departure angle 10°

C.4.8.2 TURNING RADIUS

Turning radius shall not be greater than the OEM standard.

C.4.8.3 FLOOR HEIGHT

The floor load height shall be a maximum of 34” in order to facilitate manual and/or power cot loading.

C.5 VEHICLE WEIGHT RATINGS AND PAYLOAD

C.5.1 CURB WEIGHT

Non-permanently mounted equipment is considered to be part of the payload, not the curb weight.

C.5.2 PAYLOAD CAPACITY

The required minimum payload (patients, passengers and cargo/equipment) per vehicle with optional permanently mounted equipment shall be 1,300 lbs.

Each ambulance’s payload capacity shall be determined by completing a National Truck Equipment Association (NTEA) UltraMod spreadsheet (available at www.ntea.com). A copy of the spreadsheet shall be included in the handbook of instructions. The following shall be shown on the spreadsheet:

1. Completed vehicle at curb weight
2. 171 pounds at the horizontal center of each patient location and at each seated position
3. The maximum remaining Cargo/Equipment capacity located at the horizontal center of the patient compartment that does not result in weights that exceed the vehicle’s GVWR, front or rear GAWR

Certification and payload signage as shown in Figure 1 shall include the total usable cargo/equipment



capacity value (Figure 2, item 10). The label shall be located in a conspicuous location in the ambulance.

C.5.3 GROSS VEHICLE WEIGHT RATING

The combination of the vehicle's curb weight and total usable payload weight shall not exceed the ambulance GVWR.

C.5.4 WEIGHT DISTRIBUTION

Purchasers and FSAMs shall locate vehicle-mounted components, equipment, and supplies to provide a vehicle that is laterally balanced and within the GVWR and each gross axle weight rating. The right and left wheel(s) of each axle of a completed ambulance shall be weighed to determine horizontal and lateral weight distribution. The weight distribution of a properly loaded ambulance on a level surface shall permit conformance to the FMVSS 105 braking requirements in accordance with the statements provided by the OEM. The ambulance shall conform to AMD Standard 013 (*Weight Distribution Guidelines*). All specifications and requirements for weight distribution and center of gravity of the OEM, where the OEM's requirements are more restrictive or comprehensive, shall take precedence over the requirements contained in this section.

1. The weight between the right and left side of a given axle, when on a level surface, shall be within 5%.
2. When loaded to the GVWR and within the GAWR for each axle, the front to rear weight distribution shall have not less than 20% of the total weight on the front axle, and not less than 50% nor more than 80% on the rear axle.
3. The FSAM shall locate the center of gravity (CG) of the vehicle according to the requirements set by the OEM to determine and assure that the CG of the completed ambulance does not exceed any maximum horizontal and/or vertical limits.

To meet the above weight distribution requirements, consideration shall be given by the purchaser and FSAM to locate equipment and components to permit inherently proper lateral balance, front/rear axle loading, and center of gravity position.

C.5.5 RATINGS

Vehicle and component ratings shall be the OEM's published ratings and shall not be raised above the OEM's rating.

C.6 CHASSIS, POWER UNIT, AND COMPONENTS

C.6.1 CHASSIS-FRAME

The chassis shall include the OEM's ambulance preparation package when available. The chassis-frame and components shall be constructed to withstand the strains of on-off road service and any special service and equipment requirements specified. All chassis (including cab) components shall be as represented in the OEM's technical data.

C.6.2 VEHICLE LUBRICATION

The chassis components, devices, accessories, and added equipment requiring lubrication shall be fully equipped with lubrication fittings, as provided by the OEM or equipment manufacturer.

C.6.3 POWER UNIT, ENGINE

C.6.3.1 POWER UNIT

The power unit shall meet or exceed the required vehicle performance specified at not more than the engine manufacturer's recommended operating engine speed. The OEM's diesel or gas engine and power train shall be provided. Alternative Fuel systems (for systems such as LPG and CNG) are permitted so long as they are approved by the OEM.

C.6.3.2 ENGINE LOW TEMPERATURE STARTING

The engine shall start satisfactorily without the aid of engine block preheating devices (except glow plugs) or combustion air preheater at 0°F. The determination shall be made by actual test conforming to AMD Standard 022 (*Cold Engine Start Test*) or OEM's certification.

C.6.4 POWER UNIT COMPONENTS

C.6.4.1 OIL FILTER

The oil filter shall be the OEM's standard for the engine offered.

C.6.4.2 AIR FILTER

The air filter shall be the OEM's standard for the engine offered.

C.6.4.3 AIR POLLUTION CONTROL

The vehicle and engine shall conform to 40 CFR Subchapter C-Part 86 - "Control of Emissions from New and In-use Highway Vehicles and Engines", as evidenced by an EPA certificate of compliance. Vehicles shall also comply with all pollution control requirements for the state of final destination. Certificates of compliance shall be made available upon request.

C.6.4.4 FUEL SYSTEM

The fuel system shall conform to all applicable FMVSS, Federal Motor Carrier Safety Regulations (FMCSR), Center for Advanced Research in Biotechnology (CARB), and Environmental Protection Agency (EPA) requirements. The fuel system components shall be installed, connected, and routed in accordance with all OEM's guidelines. A permanent label at the fuel filler opening shall be furnished specifying the specific type of fuel required.

C.6.4.5 COOLING SYSTEM

A coolant overflow recovery tank and compensating system shall be furnished. The cooling system shall be protected with an OEM solution of extended life antifreeze/coolant. Coolant to be the OEM's recommended type and mixture. The FSAM shall provide the OEM maximum size cooling system for the engine provided. The cooling system design shall maintain the engine at safe operating temperatures at all drivable altitudes and grades encountered during on and off road vehicle use. The engine cooling system shall conform to AMD Standard 014 (*Engine Cooling System Test*).

C.6.4.6 EXHAUST SYSTEM

The exhaust shall discharge at the vertical side(s) of the ambulance at a maximum distance of 1" beyond the side of the module and be angled /positioned to project the exhaust away from the door(s) to minimize fumes and contaminants entering the interior. On modular vehicles, the tailpipe outlet shall not terminate within 12" of the vertical axis of the fuel tank filler opening(s) when located on the same side. Modifications or extensions made to the OEM exhaust system shall meet or exceed OEM's requirements in terms of backpressure, components, design, and workmanship.



C.6.5 DRIVE TRAIN

C.6.5.1 DRIVE TRAIN COMPONENTS

The drive train and component's torque capacity shall meet or exceed the maximum torque developed in the lowest gear ratio by the engine.

C.6.5.2 AUTOMATIC TRANSMISSION

The OEM's automatic transmission shall be provided. The transmission shall provide not less than four speeds forward and one reverse and shall be equipped with the OEM's heaviest duty transmission fluid cooler.

C.6.5.3 BRAKE SYSTEMS, SERVICE AND PARKING

OEM's heaviest duty, power assisted brakes, linings, and parking brake shall be furnished on the OEM chassis offered. Antilock brake systems shall be furnished when available from the OEM.

C.6.5.4 SPECIAL TRACTION (REAR END) DIFFERENTIAL

All ambulances shall have a positive traction, limited slip differential or automatic, locking type differential, or electronic traction control.

C.6.5.5 SUSPENSION

Vehicle shall be equipped with laterally matched sets (front and rear) of suspension system components. Components shall have a rated capacity in excess of the load imposed on each member. Only corrections permitted by the OEM to compensate for lean due to normal spring tolerance variations are permitted. Correction of lean due to imbalance is not permitted.

C.6.5.6 SPRING STOPS

The OEM's standard spring bumpers and axle stops shall be furnished. The stops/bumpers shall prevent the wheel and axles from striking the engine, oil pan, fenders, and body under all conditions of operation.

C.6.6 STEERING

The OEM's standard, power assisted steering shall be furnished.

C.6.7 WHEELS

Wheels shall conform to the recommendations of the Tire and Rim Association, Inc., and shall be recommended by the OEM guidelines.

C.6.8 TIRE CHAINS AND CLEARANCE

Tire chain clearance on the furnished body shall be provided for all driving wheels per SAE J683. Sufficient chain clearance shall be provided to permit off road operation with the ambulance loaded to the maximum payload.

C.6.9 WHEEL TIRE BALANCING

Wheel/tire, hubs, and brake drum assemblies of the vehicle shall be dynamically balanced to a minimum of 70 mph.

C.6.10 WINDSHIELD WIPERS AND WASHERS

Vehicle shall be equipped with intermittent windshield wipers.

C.6.11 HORN(S)

Electric horn(s) shall be furnished.

C.7 ELECTRICAL SYSTEM AND COMPONENTS**C.7.1 ELECTRICAL SYSTEM**

The ambulance electrical system shall be equipped with, but not limited to, the following:

1. Dual, OEM's batteries.
2. Generating, starting, lighting, visual and audible warning systems.
3. Specified electronics equipment and devices (including master consoles located in the cab and patient compartment shall conform to FMVSS 101).
4. All electrical system components and wiring shall be readily accessible through access panels.
5. All switches, indicators, and controls shall be located and installed in a manner that facilitates easy removal and servicing.
6. All exterior housings of lamps, switches, electronic devices, connectors, and fixtures shall be corrosion resistant and weatherproofed.
7. Electrical fixtures attached to the exterior sides of the ambulance below the 75" level shall be near flush mounted and not protrude more than 2", except for such items as spotlights and ventilators.
8. Vehicles shall be immune from interference caused by radio transmissions (Refer to SAE J551(*Performance Levels and Methods of Measurement of Electromagnetic Compatibility of Vehicles, Boats, and Machines*)).

C.7.1.1 WARNING INDICATORS

The electrical system shall incorporate a warning light panel located in the driver's compartment. It shall provide indicator lights for:

1. Any patient compartment or exterior equipment door, installed by the FSAM, that is not closed.
2. Lights on inside the vehicle.
3. Master battery switch.

The "Door/Equipment Open" indicator in the driver's compartment can be either a warning incandescent light with at least 0.2 sq. in. of lighted surface, an electronic text message visible in all ambient lighting conditions, or LED's with equal intensity as an incandescent light source.

Electronic displays that are visible in all ambient light, that projects narrative information may be used in lieu of discrete, colored, indicator/ warning lights provided the projected message is at least as visible as the basic required warning light.

C.7.2 WIRING INSTALLATION

1. The ambulance body and accessory electrical equipment shall be served by circuit(s) separate and distinct from vehicle chassis circuits.
2. All wiring provided by the FSAM shall be copper.
3. All wiring shall have type SXL or GXL high temperature cross-linked polyethylene, or better, insulation (Refer to SAE J1128 (*Low Voltage Primary Cable*)).
4. The use of multi conductor or ribbon cables are permitted provided they are not exposed to under hood or under vehicle temperatures/conditions.
5. The wiring shall be permanently color-coded or marked the entire length of the wire.
6. Wiring shall be routed in conduit or high temperature looms with a rating of 300°F.

7. When cables are supplied by a component manufacturer to interconnect system components, these cables need not be continuously color coded/identified. They shall be coded/identified at the termination or interconnection points.
8. All added wiring should be located in accessible, enclosed, protected locations and kept at least 6" away from exhaust system components.
9. Electrical wiring and components shall not terminate in the oxygen storage compartment except for the oxygen controlled solenoid, compartment light, and switch plunger or trigger device.
10. Wiring passing through an oxygen compartment shall be protected from damage.
11. All conduits, looms, and wiring shall be secured to the body or frame with insulated cable straps.
12. All apertures on the vehicle shall be properly grommited for passing wiring.
13. All items used for protecting or securing the wiring shall be appropriate for the specific application and be standard automotive, aircraft, marine, or electronic hardware.
14. Cable ties shall not be used to support harnesses, but may be used for bundling purposes.
15. Electrical panels that are accessible to accidental contact shall have a protective cover, shield, etc. to prevent shorts that can result in injury, fire, or damage to the electrical system.
16. Wiring shall not be secured to brake lines and/or fuel lines.

C.7.2.1 WIRING CRITERIA

1. All wiring (including grounds), devices, switches, outlets, etc., except circuit breakers, shall be rated to carry at least 125% of the maximum ampere load.
2. A service loop of wire or harness shall be provided at all electrical components, terminals, and connection points.
3. All splices and terminals provided shall comply with SAE J163, J561, or J928 as applicable.
4. All terminals shall be permanently numbered or coded.
5. Terminal strip(s) block(s), or multi-pin connector(s) shall be readily accessible for checking and service.
6. All exterior wiring to lights or any other component in wet locations shall utilize sealed connectors or splices.
7. The ambulance electrical system shall incorporate a master circuit breaker panel with circuit breakers or other electronic, non-disposable, current protection devices, in each circuit, which comply with SAE J553 Type I, or Type III (if circuit breaker is readily accessible for resetting by the driver or EMSP).
8. When multiconductor cables/ribbon cables are used for low current (self limiting) circuits, additional fuses/circuit breakers are not required.
9. One extra 15-ampere circuit breaker shall be provided for future use.
10. For high current circuits, where SAE Type I breakers are not commercially produced, protection for these circuits may be provided with other types of circuit breakers.
11. All circuit breakers shall be securely mounted, easily removable, and readily accessible for inspection and service.
12. All electrical and electronic components, switches, connectors, circuit breakers, lamps, and indicators, including the vehicle batteries, shall be marked with an easily read identification code number and/or letter.

C.7.2.2 AMBULANCE CONVERSION ELECTRICAL SYSTEM – PRINTED CIRCUIT BOARDS

Printed circuit boards, which control the ambulance conversion, and installed by the FSAM, shall meet or demonstrate quality, durability and reliability performances equivalent to those specified in IPC-A-610E, Classification 1.4.1 as Class 3 "Life support or other critical Assemblies".



C.7.3 GROUNDING

Dedicated grounds for all appliances, circuits, etc. shall be furnished. The use of appliance mounting screws/hardware shall not be used for grounding purposes unless specifically designed for such use by the appliance manufacturer.

C.7.3.1 RF GROUNDING

If module is isolated from chassis, the module and chassis cab shall be connected to the chassis frame with a separate dedicated minimum 3/4", braided ground strap with soldered ends that are secured to cleaned metal surfaces on the body and frame with lock washers. To prevent corrosion, both ends of the attached ground strap shall then be sealed with either rust proofing compounds or non-hardening battery terminal sealer. Regular stranded copper wire, while providing a DC ground, does not provide RF grounding and does not meet this requirement.

C.7.4 LOW VOLTAGE ELECTRICAL SYSTEM

The ambulance shall be equipped with standard or optional generating system designed for ambulance applications, and shall be nominally rated at a minimum of 14 volts, with a minimum under hood temperature of 200°F.

The generating system shall be capable of supplying at its regulated voltage, the continuous electrical load, which consists of the following electrical equipment and systems:

1. Engine/transmission control system.
2. Headlights (low beam).
3. All FMVSS 108 lights.
4. Windshield wipers (low speed).
5. Cab air conditioning (at coldest setting with highest blower speed).
6. Radio in receiving mode (or equal load, if not equipped).
7. Patient compartment dome lighting (in the high intensity setting).
8. Patient compartment air conditioning (at coldest setting with highest blower speed).
9. Emergency warning lighting system (in the daytime "primary" mode).
10. 20 amp medical load or equivalent.

The generating system components shall be rated by the manufacturer to supply the maximum electrical load, at the regulated voltage, at a 200°F under hood temperature at an engine speed not exceeding the furnished engine manufacturer's high idle setting in order to maintain battery charge at the regulated voltage.

The throttle control device shall control the engine's revolutions per minute (RPM) necessary to maintain the heating and air conditioning systems, at full operating capacity, and to maintain the generating system's required output when the vehicle is stationary.

The 12-volt electrical system shall incorporate a voltmeter and low voltage-warning device, which is functionally connected as shown in Figure 3. The FSAM shall test each ambulance, in accordance with AMD Standard 005 (*12-Volt Electrical System Test*), prior to delivery and provide, to the purchaser, a written certification indicating the amount of generating capacity remaining, at the regulated voltage after supplying the total electrical load as manufactured (including the purchaser options).

C.7.4.1 ENGINE HIGH-IDLE SPEED CONTROL

An engine high-idle speed control shall be furnished. The control shall be set to automatically increase

the engine speed to the engine manufacturer's recommended setting to sustain the ambulance's total continuous electrical load at the regulated voltage and provide maximum heating/air conditioning output.

The device shall operate only when switched to the "ON" position and the transmission is in "PARK" or "NEUTRAL" and parking brake applied.

The device shall disengage high-idle operation according to OEM and/or engine manufacturer disablement strategy, or if not specified, when the operator depresses the service brake pedal or the transmission is placed in gear.

C.7.4.2 VOLTMETER AND VOLTAGE MONITOR

A voltmeter illuminated for nighttime operation shall be furnished. The electrical system shall be monitored by a system that provides an audible and visual warning in case of low voltage to persons in the ambulance of an impending electrical system failure caused by the excessive discharge of the batteries. The charge status of the battery shall be determined by direct measurement of the battery voltage. The alarm shall sound if the system voltage at the battery drops below 11.8 V for 12 V electrical systems for more than 120 seconds.

C.7.5 BATTERY SYSTEM

Two batteries (or additional batteries as required by the OEM) for ambulance use shall be furnished. Batteries shall be located in a ventilated area, sealed off from occupant compartments, and shall be readily accessible for servicing and removal, with the exception of OEM-installed batteries.

C.7.5.1 AUTOMATIC CHARGER/CONDITIONER

An automatic charger/conditioner shall be provided. The charger/conditioner shall:

1. Be connected to the 12-volt DC battery system as shown in Figure 3.
2. Be capable of supplying a minimum of 10 amperes charging current.
3. Be permanently mounted, in the vehicle, in a properly ventilated, accessible location and wired to the 125-volt AC utility power as shown in Figure 4.
4. Monitor the battery state of charge and, as necessary, automatically charge or maintain the batteries without gassing, depleting fluid level, overheating, or overcharging.

C.7.5.2 PORTABLE EQUIPMENT CHARGING CIRCUIT

A circuit shall be furnished (Figure 5) for charging all portable battery powered devices, i.e. suction units, hand lights, defibrillators, portable radios, etc. This circuit shall prevent discharge of chassis batteries by only permitting the charging of portable devices when the vehicle is either running or the automatic charger/conditioner is connected to shore power. Circuit breaker protection shall be provided and shall have a minimum 10 amp capacity.

C.7.5.3 INTERNAL 12-VOLT DC POWER (*REFER TO FIGURE 3*)

Two automotive "Power Point" type connectors shall be furnished, in the patient compartment. Each connector shall be rated for 12-volt DC, 20 ampere capacity, and be on a separately protected circuit. This circuit shall provide a means of isolating the medical equipment batteries from any electrical loads that the remainder of the ambulance electrical system may impose.

C.7.5.4 MASTER MODULE DISCONNECT SWITCH OR DEVICE

An illuminated "Module Disconnect" switch shall control all electrical loads added by the FSAM, or an

illuminated switch controlled solenoid as shown in Figure 3. This switch shall be located in the driver's compartment, be legibly marked, illuminated when "ON," and rated to carry at least 125% of the circuit's maximum current. The module disconnect switch or device shall be different in feel from other switches, or be physically isolated from them.

C.7.6 125-VOLT AC UTILITY POWER (REFER TO FIGURE 4)

The ambulance shall be furnished with a 2-wire plus ground 125-volt AC wiring system that is separate and distinct from the vehicle's DC wiring system(s). The AC system is to be utilized while the vehicle is stationary for powering maintenance devices, medical equipment and battery chargers. The AC system shall not be utilized for operational ambulance interior lighting, such as dome and cot lights.

C.7.6.1 UTILITY POWER CONNECTOR

A 125-volt AC flanged inlet rated for a minimum of 15 amperes conforming to the National Electrical Manufacturers Association's (NEMA) specifications appropriate for the voltage and amperage, with spring loaded cover assembly suitable for wet locations, shall be installed. The connection shall be permanently labeled with the proper voltage and amperage rating.

This receptacle shall energize the vehicle's internal AC circuit from an external power source (utility power). The purchaser's stationary utility power circuit supplying the ambulance's 125-volt AC power should incorporate ground fault protection. A proper mating, weatherproof, 15 ampere connector body rated for a minimum of 15 amperes conforming to NEMA specifications appropriate for the voltage and amperage shall also be furnished without cable and tagged specifying the size, type of wire necessary, and the polarity of the future hookup.

C.7.6.2 ELECTRICAL 125-VOLT AC RECEPTACLES

The patient compartment shall be furnished with two (2) 125-volt AC duplex receptacles conforming to NEMA 5-15. Receptacles shall be near flush installed on vertical surfaces. All interior outlets shall be installed in accordance with Section 210-7 (Receptacles and Cord Conductors) of the National Electrical Code (NEC). Outlets shall be at least 12 in from any oxygen outlet. An indicator shall be located within each 125-volt AC receptacle as a line monitor indicating a live (hot) circuit. The receptacles shall be labeled with the following: "125-VOLT AC."

C.7.6.3 125-VOLT AC SYSTEMS

1. The electrical equipment and material indicated for connection to a wiring system rated 125 volts, nominal, 2-wire with ground shall incorporate a minimum 15 ampere circuit breaker which can be used as a master AC disconnect switch.
2. The AC wiring shall utilize stranded wire, Type SO or Type SEO cord with a WA suffix, rated at 600V and 194°F, covered with a minimum 300°F flame retardant wire loom, or approved wire in conduit.
3. Grounding shall be in accordance with Section 250-6 (*Portable and Vehicle Mounted Generators*) of the National Electrical Code (NEC).
4. All 125-volt AC receptacle outlets of the ambulance shall have ground fault circuit interrupter protection.
5. Where rigid metal conduit or intermediate metal conduit is terminated at an enclosure with a lock nut and bushing connection; two lock nuts shall be provided, one inside and one outside of the enclosure. All cut ends of conduit shall be reamed or otherwise finished to remove rough edges.
6. Boxes are required for all inlets and/or outlets.
7. Non-metallic boxes shall be acceptable only with non-metallic conduit.



8. Boxes shall be mounted in accordance with Article 370 (*Outlet, Device, Pull And Junction Boxes, Conduit Bodies And Fittings*) of the NEC.
9. No bend shall have a radius of less than five times the cable or conduit diameter, whichever is greater.
10. Tubing, conduit and loom shall be supported with clamps at the outlet boxes, distribution panel boards and splice boxes on appliances. Supports shall be provided every 24".
11. Where subject to physical damage, exposed type SO cable will be protected by guard strips, raceways or other means.
12. The branch circuit over current devices shall be rated:
 - a. Not more than the circuit conductors, and
 - b. Not more than 150% of the rating of a single appliance rated 13.3 amperes or more and supplied by an individual branch circuit, or according to the appliance manufacturer, but
 - c. Not more than the over current protection size marked on motor-operated appliances
13. 125-Volt AC System shall conform to AMD Standard 009 *125-Volt AC Electrical Systems Test*).

C.7.6.4 DISTRIBUTION BOX

1. The distribution box shall be of the dead-front type and shall be installed in a readily accessible location.
2. The distribution panel board shall have a grounding bus with sufficient terminals for all chassis grounding and separate neutral grounding conductors or other approved grounding means.
3. The grounded circuit conductor (neutral) shall be insulated from the equipment grounding conductors and from equipment enclosures and other grounded parts. The grounded (neutral) circuit terminals in the distribution panel board and in appliances shall be insulated from the equipment enclosure.

C.7.6.5 INTERIOR EQUIPMENT GROUNDING

1. In the electrical system, all exposed metal parts, enclosures, frames, fixtures, canopies, etc., shall be effectively bonded to the grounding terminals or enclosure of the distribution panel board.
2. Only bare wires, green colored or green wires with yellow stripes shall be used for equipment grounding conductors.
3. Grounding of electrical equipment shall be provided as follows:
 - a. Connection of metal raceway, i.e., conduit or electrical metallic tubing.
 - b. A connection between the one or more equipment grounding conductor and a metal box by means of a grounding screw (which shall be used for no other purpose) or a listed grounding device.
 - c. The equipment grounding conductor shall be permitted to be secured under a screw threaded into the fixture canopy other than a mounting screw or cover screw or attached to a listed grounding means (plate) in a non-metallic outlet box for fixture mounting (grounding means shall also be permitted for fixture attachment screws).
 - d. A connection between the one or more equipment grounding conductors brought into a non-metallic outlet box shall be so arranged that a connection can be made to any fitting or device in that box which requires grounding.
 - e. Where more than one equipment grounding conductor or branch circuit enters a box, all such conductors shall be in good electrical contact with each other and the arrangement shall be such that the disconnection or removal of a receptacle, fixture, or other device fed from the box will not interfere with or interrupt the grounding continuity.
 - f. Cord-connected appliances shall be grounded by means of an approved cord with equipment grounding conductor and grounding attachment plug.

C.7.6.6 BONDING OF NON-CURRENT-CARRYING METAL PARTS

1. All exposed non-current carrying metal parts that may become energized shall be effectively bonded to the grounding terminal or enclosure of the distribution panel board.
2. A bonding conductor shall be connected between the distribution panel board and an accessible terminal on the chassis. Aluminum or coppered aluminum conductors shall not be used. Any ambulance that employs a unitized metal chassis-frame construction to which the distribution panel is securely fastened with a bolt and nut shall be considered to be bonded.
3. Grounding terminals may be of the solderless type and listed as pressure terminal connectors recognized for the wire size used. The bonding conductor shall be copper strand and equal in amperage capacity to the main supply cables.
4. The ambulance body and exterior covering shall be considered bonded where:
 - a. The metal panels overlap one another and are securely attached to the metal frame parts by metal fasteners or welding and
 - b. The lower panel of the metal exterior covering is secured by metal fasteners at each cross member of the chassis, or the lower panel is bonded to the chassis by a metal strap.
 - c. Metal circulating air ducts shall be bonded.
 - d. The compressed gas pipes shall be considered bonded if they are bonded to the chassis.

C.7.6.7 APPLIANCE ACCESSIBILITY AND FASTENING

All electrical appliances shall be accessible for inspection, service, repair, and replacement without removal of permanent construction. Appliances shall be fastened in accordance with the manufacturer's directions.

C.7.7 DRIVER COMPARTMENT CONTROLS

In addition to the left-hand drive controls and switches, the FSAM shall provide and locate, within easy reach and view of the driver, the purchaser-specified controls, and instruments.

C.7.8 PATIENT COMPARTMENT CONTROLS

The purchaser-specified patient compartment controls, switches, and instruments shall be mounted and located within reach of the primary seated and restrained EMSP.

C.7.9 MARKING OF SWITCHES, INDICATORS, AND CONTROL DEVICES

All switches, indicators, and control devices supplied by the FSAM shall be clearly visible to the EMSP. They shall be perceptively and permanently identified with at least 12-point letters for the noun or function, and 10 point letters for the remainder of the legend; appropriately identified pictograms (or symbols) are also acceptable. The identifications shall be contrasting colors etched or engraved in plastic or metal, or printed and laminated in see through plastic, and grouped according to function, and mounted in illuminated or backlit panel(s) or the console.

C.7.10 ELECTROMAGNETIC RADIATION AND SUPPRESSION

In addition to OEM chassis, all added electrically operated or electrical generating devices, including alternators, air conditioning, warning light systems, electromagnetic coils of high current solenoids and relays, and medical equipment, shall be electromagnetic radiation suppressed, filtered, or shielded to prevent interference to radios and telemetry equipment aboard the vehicle and the surrounding area and shall not exceed MIL-STD 461 limits per Ground Navy in Figure 5 of the requirement. Type certification for these devices is acceptable.



C.8 LIGHTING, EXTERIOR AND INTERIOR

C.8.1 AMBULANCE EXTERIOR LIGHTING

The basic exterior ambulance lighting shall include daytime running lights. The lower front and rear side marker lights shall flash in conjunction with the directional signals. The FSAM shall furnish light assemblies that are manufactured with weather resistant materials that are installed in a manner that will not cause electrolysis of light housings or vehicle body. Ambulance exterior lighting shall conform to FMVSS 108.

C.8.2 AMBULANCE EMERGENCY LIGHTING

An emergency lighting system shall provide the ambulance with 360° of conspicuity for safety during its missions. The system shall display highly perceptible and attention getting signals that function in a modal system, and convey the message in the “PRIMARY MODE” — “Clear the Right-of-Way” and in the “SECONDARY MODE” — “Hazard, Vehicle Stopped on Right-of-Way.”

Warning light systems shall not impair the effectiveness of the ambulance’s exterior lighting with conformity to the requirements of FMVSS No. 108.

C.8.2.1 EMERGENCY LIGHTING SYSTEM CONFIGURATION

The purchaser shall specify emergency warning light systems, for the vehicle, to the manufacturer. Patterns and configurations shall comply with any related state or local regulation. These lights shall function in a dual mode system as shown in Table 1 and meet the physical and photometric requirements. All warning lights furnished shall be mounted to project their highest intensity beams on the horizontal plane.

Alternate approved lighting systems shall be either NFPA 1901 compliant or SAE J2498 compliant.

TABLE 1 – RECOMMENDED EMERGENCY LIGHTING

Consult with all local and state requirements governing emergency lighting color and placement.

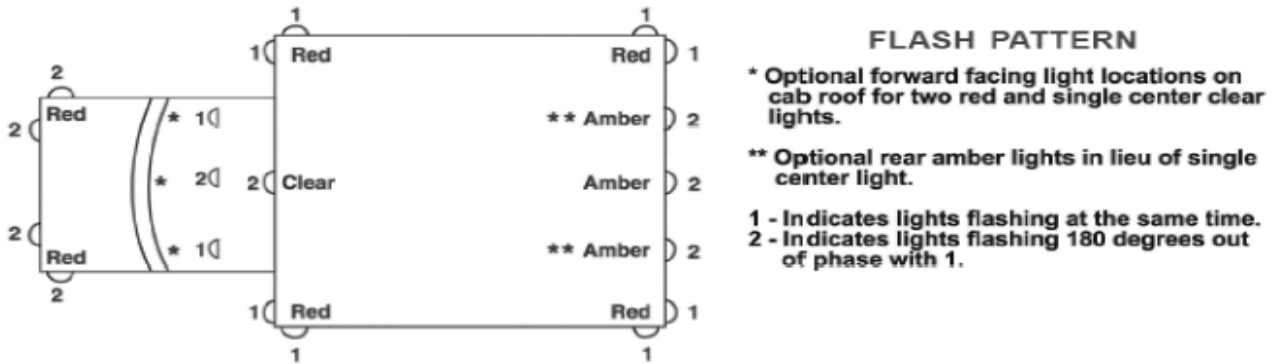

MINIMUM FLASH ENERGY, Cd-S PER FLASH, PER FIXTURE				
COLOR	RED		CLEAR	AMBER
LOCATION	GRILL & FENDERS	UPPER BODY CORNERS	FRONT CENTER	REAR CENTER*
DAY	160 Cd-S @ HV	240 Cd-S @ HV	900 Cd-S @ HV	600 Cd-S @ HV
	80 Cd-S @ ± 5° H Points	120 Cd-S @ ± 5° H Points	450 Cd-S @ ± 5° H Points	300 Cd-S @ ± 5° H Points
	12 Cd-S @ All 5° V - 45° H Points	32 Cd-S @ All 5° V - 45° H Points	96 Cd-S @ All 5° V - 45° H Points	72 Cd-S @ All 5° V - 45° H Points
NIGHT	10 - 30% of the above			

* Single center rear or combined dual rear (Optional)

MODAL EMERGENCY LIGHTING SYSTEM				
COLOR & LOCATION	RED	CLEAR	AMBER	RED
	Front and Rear Corners	Front Upper Center	Rear Center	Grille and Fender
PRIMARY "Clear the Right-of-Way"	ON	ON	ON	ON
SECONDARY "Hazard-Vehicle Stopped on Right-of-Way"	ON	OFF	ON	OFF

C.8.2.2 PHOTOMETRIC, CHROMATICITY, AND PHYSICAL REQUIREMENTS

Each emergency light shall flash 75 to 125 times per minute. The chromaticity values of the lights shall conform to SAE J578, for their respective color, except for the red lights, which may conform to the following expanded boundary limits of: $y = 0.34$; $y = 0.32$; $x = 0.62$. All warning lights shall project a beam spread of at least 5° up and 5° down and at least 45° left and right of H-V. Each light shall produce flash energy, (Cd-s) per flash, measured from the H-V to all the extreme test point coordinates and shall be tested at all 5° increments. At no point shall the Cd-s values drop to less than the

minimum values as shown in Table 1 (*above*) when tested at 14.2 volts. Flash energy shall be determined in accordance with the SAE J845 method for determining the flash energy of a light. Testing shall be conducted on the device(s) as manufactured including use of the actual light source and all other related system components.

C.8.2.3 SWITCHING ARRANGEMENTS

The emergency light switches shall be wired and arranged to provide the warning light signal modes and combinations as specified. All emergency light switches shall be labeled and each Primary/Secondary mode switch shall have indicator light to show the driver which mode is activated.

C.8.2.4 HARDWARE CONSTRUCTION AND INSTALLATION

The emergency lighting system shall be comprised of components and devices that comply with the general requirements and tests of SAE J575, J576, J578, and J551, as applicable for the unit. Warning lights shall be firmly fastened to reinforced body surfaces in accordance with the lighting manufacturer's requirements and recommendations and include aiming wedges to compensate for sloped body surfaces, grill, hood and fender angles or mold release angles on roof caps. The FSAM shall aim the lights to assure that all lighting performance requirements herein are met. The lights shall be aimed either mechanically or optically on the horizontal axis with a tolerance of +0° to -3°. All switches, connectors, and wiring shall be rated to carry a minimum of 125% of their maximum ampere load. When halogen or other long duty cycle light source is used, the duty cycle of any device shall not exceed 50%. When strobe lights are furnished, all high voltage leads and connections shall be insulated and enclosed, or weatherproof connectors, with the proper voltage rating shall be used.

C.8.2.5 TESTS, WARNING LIGHT SYSTEM

The lighting manufacturers shall furnish and certify or the FSAM shall measure and record the total average current load of the standard emergency warning light system on the vehicle as manufactured at the regulated voltage of 14.2 volts, when operated in the mode which draws maximum current. The warning light system and related components and devices shall be tested and approved by an Automotive Manufacturers Equipment Compliance Agency (AMECA) accredited laboratory independent from the lighting device manufacturer's own labs and listed with the AMECA for compliance with the requirements in this standard.

C.8.3 FLOOD AND LOADING LIGHT (EXTERIOR)

Flood and loading lights shall be not less than 75" above the ground and unobstructed by open doors. Floodlights shall be located on the sides, and a patient loading light shall be located on the rear of the ambulance and shall conform to AMD Standard 024 (*Perimeter Illumination Test*). They shall be fastened to reinforced fixed body surfaces. Floodlight switches shall be located on the cab console and control each side independently. Rear or side floodlights shall activate when the respective patient compartment access door is opened.

C.8.4 AMBULANCE INTERIOR LIGHTING

The basic interior ambulance lighting configuration shall be designed to minimize electrical loads and include: A driver's compartment dome light; instrument panel lights; master switch panel; and console light(s). The EMSP's control panel shall be separately illuminated. All lights shall have lamp-shells and housings grounded.

C.8.4.1 PATIENT COMPARTMENT ILLUMINATION

The patient compartment floor shall not be less than 15-foot candles intensity, measured along the

centerline of the clear floor. The primary cot shall be provided with a minimum of 50-foot candles of illumination measured on at least 90% of the cot's surface area. The patient compartment illumination shall conform to AMD Standard 016 (*Patient Compartment Lighting Level Test*).

Blue light(s) or lenses shall not be used. Patient compartment lights shall not be powered by the vehicle's AC system if so equipped. The patient compartment dome lighting (in the dim setting) shall be automatically activated when the side entry or rear entry patient compartment doors are opened. All interior dome lighting, including "checkout" lights, shall be near flush mounted and not protrude more than 1.5".

Dome lighting shall have two separately protected and controlled circuits. Switches, electronic controls, or fireproofed rheostats may be used to control lighting.

C.9 CAB-BODY DRIVER COMPARTMENT AND EQUIPMENT

C.9.1 DRIVER'S COMPARTMENT, CAB-BODY STRUCTURE

The driver's cab shall be of sufficient size to accommodate a driver and passenger, with space to perform driving and control activities. The driver's cab shall be organized and designed with the specified and required equipment and accessories for ease of operation and safety.

C.9.1.1 AFTER-MARKET EQUIPMENT

It is the responsibility of the manufacturer to comply with all applicable Federal and state laws and regulations regarding FSAM installed equipment. In addition, it is the responsibility of the purchaser and any after-market installer to ensure that all after-market equipment does not impact the safety of the vehicle or its occupants.

C.9.2 DRIVER'S CAB-BODY PROVISIONS

An OEM chassis shall be furnished that is suitable for the subsequent mounting of various ambulance equipment and bodies. The driver's cab section at a minimum, shall provide:

1. Forward hinged doors.
2. Opening side windows.
3. Door stops.
4. Trim or closed panels and headliner.
5. Floor covering (OEM's heat, noise and appearance trim packages).
6. Panel mounted instruments.
7. Armrests, mounted on each side door.
8. Fuel indicator(s).
9. Oil pressure indicator.
10. Engine temperature indicator.
11. Speedometer with odometer.
12. Environmental controls (heater-defroster/air conditioner, etc.).
13. Cab lighting and controls.
14. Tinted windshield.
15. Dual electric horn(s).

C.9.3 CAB COMPARTMENT DRIVER AND PASSENGER SEAT

The driver's compartment shall be OEM two individual bucket-type seats (driver and passenger). Driver's seat shall have the OEM's full, unobstructed seat track travel range of longitudinal adjustment,

and a minimum of 30% of the range of inclination, but not less than the angle furnished on the OEM's standard non-reclining high back seat.

C.9.4 CONTROLS AND OPERATING MECHANISM

All controls and operating mechanisms shall be located for left-hand drive. Lever controls, equipment, items, and devices shall be installed, located, and stowed for the convenience of the purpose intended and shall not interfere with the EMSP or patient's ingress or egress of respective compartments.

C.9.5 OUTSIDE REARVIEW MIRRORS

Dual power rearview OEM mirrors having a combination flat/convex mirror system shall be furnished. The mirrors shall be the largest available from the OEM. When available from the OEM, all four mirror head faces shall be independently adjustable. The driver and passenger side door mirror shall be adjustable from the interior of the vehicle by an electric switch, which can modify the angle of the mirror surface. Hardware and mirror heads shall have a corrosion resistant exterior finish.

RECOMMENDED ENHANCEMENT – Backup Camera: *Power rear view backing camera should be provided to ensure visual safety.*

C.9.6 BUMPERS AND STEPS

OEM's standard chrome bumper shall be furnished in the front of the chassis. The rear of the ambulance shall be furnished with a sturdy, full-width, rear bumper, with step secured to the vehicle's chassis- frame. The bumper-step shall be designed to prevent the accumulation of mud, ice, or snow and made of antiskid open grating metal. These steps shall not be located or exposed to the interior of the ambulance when the door(s) are closed. All necessary steps shall be at least the width of the door opening for which they are provided. The step's tread shall have a minimum depth of 5" and a maximum depth of 10". If the step protrudes more than 7" from the rear of the vehicle, a fold up step shall be furnished. The rear bumper and step shall be adequate to support a test weight of 500 lbs and shall conform to AMD Standard 018 (*Rear Step and Bumper Static Load Test*). The height of the rear step shall not exceed 22".

RECOMMENDED ENHANCEMENT – UNDERCARRIAGE LIGHTS: *Undercarriage lights may be added to the vehicle, positioned around the perimeter of the vehicle in areas that require regular visual safety. A control module shall operate the lights in coordination with an ignition switch, a manual switch inside/outside the truck, and/or a low light sensor.*

C.9.7 BODY PROTECTION

C.9.7.1 FENDERS

Fenders and wheel housings shall be provided to cover all tires.

C.9.7.2 MUD FLAPS

Mud flaps, at least as wide as the tire(s), shall be provided behind the front and rear wheels and shall be reinforced at the point of attachment to the vehicle. Mud flaps may be incorporated into the running boards.

C.9.7.3 FUEL FILL SPLASH PLATES

The painted surface of the ambulance body shall be protected from discoloration due to spilled fuel

during refueling. Protection shall be provided by a drain in the fuel fill housing(s) or by splash plate(s) under the fuel fill opening.

C.9.8 ENGINE HOOD

Engine hood and cowl shall be fitted to prevent precipitation, heat, odors, and noise from entering the interior of the cab and body. Cab compartment engine covers shall be removable for easy access to engine and components.

C.9.9 CAB CONNECTING BELLOWS FOR TYPE I & I AD VEHICLE

A flexible, weather-tight bellows, fabricated from Ethylene Propylene Terpolymer Rubber (EPDM), Hypalon, sheet or molded rubber, or other durable materials that meet the temperature requirements herein and resist ozone, sunlight, oil, fungus, and will not crack, rot or deteriorate, shall be provided between the cab and the modular body. Bellows shall be designed for proper fit and finish and be able to absorb lateral, vertical, and torsional displacement due to body/cab movement.

C.10 AMBULANCE BODY AND PATIENT AREA

C.10.1 BODY ACCOMMODATIONS

The ambulance body and patient compartment shall be sufficient in size to transport occupants and all specified stretchers, cots, and litters. There shall be space around the patient(s) to permit an EMSP to administer care/treatment to the primary patient during transit.

C.10.2 CAB/PATIENT COMPARTMENT ACCESS WINDOW

The ambulance and body bulkheads shall have an aligned window opening of at least 150 sq. in., for visual checking and voice communications between the driver's cab and the patient compartment for non-walk through vehicles. The window in the cab or body shall be of the sliding type, shall be aligned, and connect with the modular body window opening and shall conform to requirements of the partition. The window shall be an adjustable, transparent, shatterproof panel. If a full height partition or bulkhead (with or without compartments) is included in the design, it shall be placed between the driver and patient's compartment. This partition shall be located directly behind the driver and companion seats when in the rearmost position. The partition shall be secured on the sides, ceiling, and/or floor by welding or bolting to tapping plates.

RECOMMENDED ENHANCEMENT – DOOR / WALKTHROUGH FOR TYPE II, III, AND III AD

VEHICLES: Walkthrough door openings on vehicles may be at least 17" wide and 46" high and may provide an aisle between the compartments. The door may have at least a 150 sq. in., transparent, shatterproof viewing panel in the center section at the driver's eye level. The door may be secured with a driver's side self-latching device in the open and closed positions.

C.10.3 EMERGENCY MEDICAL SERVICES PROVIDER (EMSP) SEATING

The EMSP shall be located to allow for the care of the primary patient. The seating location(s) shall be specified by the purchaser.

C.10.4 PATIENT COMPARTMENT INTERIOR DIMENSIONAL PARAMETERS

The patient compartment shall provide a minimum of 325 cubic feet of space (275 cubic feet of space for a Type II), less volume for cabinets, while complying with the following:

1. The compartment configuration shall provide at least 25" of unobstructed space at the head of the primary patient, measured from the face of the backrest of the EMSP seat to the nearest edge of the cot.
2. The compartment shall provide a clear aisle walkway between the edge of the primary patient cot and base of the nearest vertical feature measured along the floor. Each end of the walkway shall provide access to a means of egress.
3. The patient compartment shall provide at least 60" height, over the primary patient area, measured from floor to ceiling panels.

RECOMMENDED ENHANCEMENT – WALKWAY SPACE: *Twelve inches (12") of clear aisle walkway space should be provided on the side where the primary EMSP is operating.*

C.10.5 BODY, GENERAL CONSTRUCTION

For modular construction, the body shall be all welded aluminum or, other lightweight, inherently corrosion resistant materials of equal, or greater, strength. Ambulance body, as a unit, shall be designed and built to provide impact and patient compartment penetration resistance and shall be of sufficient strength to support the entire weight of the fully loaded vehicle on its top or side, if overturned, without separation of joints or permanently deforming roof bow or reinforcements, body posts, doors, stringers, floor, inner linings, outer panels, rub-rails, and other reinforcements. Ambulance body shall conform to AMD Standard 001 (*Ambulance Body Structure Static Load Test*). Wood, or wood products, shall not be used for structural framing.

The roof structure, liner, and outer skin or cap shall be designed and constructed to prevent separation.

Any absorbent material such as carpeting, fabric, or inside/outside plastic type carpeting, etc. that resists cleaning and decontamination shall not be used.

C.10.6 AMBULANCE BODY STRUCTURE

All parts of the ambulance body and attachments shall be fastened in a manner that will preclude loosening. All fasteners shall be of the corrosion resistant type. Cabinets, seats, partitions, oxygen cylinder holders, guide rails, and cot holders shall be attached to metal tapping plates and/or framing attached to the body structure.

Patient compartment grab rails shall conform to AMD Standard 008 (*Patient Compartment Grab Rail Static Load Test*). These components shall be fastened by welding, bolting, or self-tapping (threading) machine screws, on a minimum of 18" centers. Sheet metal, self-tapping wood/metal screws, nails, staples, etc. shall not be used in assembling the ambulance structure, except for self-threading sheet metal screws used for light trim panels and for retention of wood or composite sub-flooring.

Ambulance bodies with an extended roof shall have the roof structural members permanently fastened to structural members of the body.

Drip rail(s) shall be provided around the entire modular body and have drain points at each corner. Drip rails shall also be furnished over each entry and compartment door.

The body, roof, and panel joints shall be watertight and shall conform to AMD Standard 010 (*Water Spray Test*).

All openings between the chassis-body and occupant carrying compartments shall be sealed to prevent intrusion of water, dust, and exhaust gases and shall conform to AMD Standard 007 (*Patient Compartment Carbon Monoxide Level Test*).

C.10.7 BODY MOUNTING

On modular ambulance bodies, to reduce stress on body and frame, minimize height above the frame, and isolate the patient compartment from noise and vibration, full floating, automotive style, rubber body mounts shall be furnished. A minimum four body mounts per frame rail not to exceed the mechanical properties of the body mounts and fasteners shall be furnished. Fasteners shall be a minimum of Grade 8.

C.10.8 DOORS

Two patient compartment door openings shall be provided. They shall not be on the same side of the vehicle. The user may specify only one door as long as patient egress is possible (space should allow for movement of patient on standard size backboard). Door systems must meet FMVSS 206 (*Door Locks and Door Retention Components*).

C.10.8.1 PROTECTION OF PATIENTS AND CREW (DOORFRAME)

Upholstered padding/cushions shall be provided at the upper interior areas of the doorframes.

C.10.8.2 STEP WELL (*SIDE DOOR IF APPLICABLE*)

Steps shall be provided in the door openings. Steps at the entry/exit of doorways shall be at least the width of the doorway internal frame opening. Step well shall be the enclosed two-step type. Height of the bottom step shall not exceed 22". Step wells shall be lighted, and all step surfaces shall be constructed with anti-slip material.

C.10.9 DOOR LATCHES, HINGES, AND HARDWARE

1. When doors are open, the hinges, latches, and door-checks shall not protrude into the access area.
2. All doors shall have hardware or devices to prevent inadvertent closing.
3. To facilitate entry and exit from the vehicle, a minimum 6", tubular or semi-oval, minimum 3/4" wide (diameter), grab handle shall be provided on the inside of each door or the adjacent body structure (in addition to a door operating handle).
4. One external operated lock, with key per door opening, shall be provided.
5. All patient compartment door locks shall be identically keyed.
6. Hardware shall be weather resistant.

RECOMMENDED ENHANCEMENT – FAIL SAFE DEVICE: *A Fail-Safe Device should be incorporated into all patient compartment access doors.*

C.10.10 FLOOR

1. The floor shall be flat, except when the area near the rear entrance door is sloped for a lower entering height.
2. With the exception of cot related hardware, shall be unencumbered in the door(s) access and work area.
3. Shall support a "Distributed Loads" Medium footprint of 400 lbs and shall conform to AMD Standard 020 (*Floor Distribution Load Test*).
4. Metal floors shall be reinforced to eliminate "oil canning."

5. Floors shall be insulated against outside heat and cold and shall conform to AMD Standard 012 (*Interior Climate Control Test*).
6. The sub floor of the modular body patient compartment shall be water resistant.
7. When plywood is utilized, it shall be water resistant.
 - a. Not less than 1/2" thick, 5 ply minimum.
 - b. Shall be supported by body framework.
8. Under the sub floor of the modular body shall be an aluminum heat shield/splash pan, minimum 0.050", sealed with silicone or other non-hardening sealant evenly distributed around its perimeter.
9. The sub floor of the Type II patient compartment shall be not less than 1/2" thick density, marine or exterior grade plywood or similar-strength synthetic material.
10. Fiberglass, aluminum, or other non-hygroscopic composites, with at least the equivalent strength of plywood may be used as the sub floor.
11. Particleboard or equivalent type materials are not acceptable.
12. Voids or pockets, where water or moisture can become trapped to cause rotting and unsanitary conditions, are not acceptable.
13. Voids and pockets shall be filled with sealer or caulking compound.
14. Flooring shall extend the full length and width of the patient compartment or body (including space under the cabinets, unless otherwise insulated) or prevented by exterior compartment bodies or wheel wells that extend above floor level.

C.10.11 FLOOR COVERINGS AND COLOR

Floor covering shall be easily cleaned, sanitized, and harmonize with the interior color and décor of the patient compartment. The floor covering shall be seamless, one piece, no wax type, solid linoleum, vinyl, or poured epoxy or acrylic not less than 1/16" thick and permanently applied to the sub floor. The floor material shall cover the entire length and width of the compartment's working area. The covering of joints (corners, etc.), where the sidewalls and covering meet, shall be sealed and bordered with corrosion resistant cove molding or the covering shall extend at least 3" up the sidewalls.

C.10.12 WHEEL HOUSINGS

Wheel housings of modular bodies shall include metal or plastic splash shields between the body wheel housing and the wheels extending over the top of the tires to the bottom of the body side skirting. Wheel house openings shall allow for tire chain usage and easy tire removal and service. OEM's standard wheel housings will be acceptable.

C.10.13 INSULATION

The entire body, sides, ends, and roof of the patient's compartment shall be completely insulated to enhance the performance of the environmental systems and prevent external noise from entering the vehicle interior. The insulation shall be a non-settling type, vermin-proof, mildew-proof, fire retardant, non-toxic, and non-hygroscopic. If fiberglass insulation is used, it shall not be exposed to water, e.g. door panels.

C.10.14 INTERIOR SURFACES

The interior of the body shall be free of all sharp projections. All hangers or supports (these include, but not limited to: Grab Bar, IV hooks, Outlets, Control panels, O2 port, lights, cabinetry hardware, switches, door/drawer latches) shall be mounted flush or as flush as possible with the surrounding surface. Interior body lining and cabinetry materials, excluding the cab compartment, shall be selected



to minimize dead weight. Swing down hangers/bracket with rigid support arms that can cause injury shall not be specified or furnished.

The finish of the entire patient compartment, including interiors of storage cabinets, shall be:

1. Impervious to soap, water and disinfectants.
2. Easily cleaned/disinfected (carpeting, cloth, and fabrics are not acceptable).
3. Mildew resistant.
4. Fire resistant.

Any absorbent material such as carpeting, fabric, or inside/outside plastic type carpeting, etc. that resists cleaning and decontamination shall not be used in any storage or patient compartment.

C.11 STORAGE COMPARTMENTS

Equipment, supplies, devices, tools, etc., shall be stored in enclosed compartments, cabinets, drawers or appropriate mounts designed to accommodate the respective items.

C.11.1 INTERIOR STOWAGE ACCOMMODATIONS

The purchaser shall specify to the manufacturer, the amount and layout of enclosed stowage. Compartment(s) under the floor, with opening panel(s) inside the patient compartment, shall not be acceptable.

C.11.1.1 MOUNTING AND LOCATION OF MEDICAL EQUIPMENT AND SUPPLIES

For any equipment and materials over 3 lbs, not otherwise stowed in a cabinet, equipment mounts or retention devices shall be utilized. The mounts or retention devices shall be installed according to the mount or retention device manufacturer’s directions.

RECOMMENDED ENHANCEMENT – MOUNT TESTING: These mounts should be tested in accordance with the requirements of SAE J3043 (*Ambulance Equipment Mount Device or Systems*).

The purchaser shall specify to the manufacturer the desired location and structural requirements for mounting equipment. The manufacturer shall place an appropriate structure in the vehicle to provide support for such an installation.

C.11.1.2 WASTE AND SHARPS DISPOSAL

The following shall be furnished: A trash receptacle compartment, with closure over opening, for general waste shall be furnished with a plastic/rubber trash can and disposable plastic liners. The trash compartment shall be accessible to the EMSP seat. A sharps receptacle compartment/storage or a commercially available container mounted in a convenient area shall be furnished for retention of a sharps container that is compliant with OSHA CFR 1910.1030. The sharps container must have a locking system that will remain closed in a crash.

RECOMMENDED ENHANCEMENT – MOUNT TESTING: Any sharps container mounted alone (ie. outside of a cabinet) should be tested in accordance with SAE J3043 (*Ambulance Equipment Mount Device or Systems*).

C.11.2 EXTERIOR STORAGE ACCOMMODATIONS

Ambulance exterior storage compartments shall be weather resistant. Exterior compartment doors and hardware shall be flush or near flush style construction. All doors shall have spring or gas tube type, hold open devices that permit one hand closure opening. Hardware (hinges, locks, latches, etc.) shall be rust resistant. All exterior compartments shall have latches with locks. All exterior compartments shall be automatically lighted when opened. Volume of exterior storage accommodations shall be determined using AMD Standard 019 (*Measuring Guidelines: Cabinets and Compartments*).

C.11.3 STORAGE COMPARTMENTS AND CABINETS DESIGN

Storage cabinets and drawers shall be easily opened but shall not come open in transit. For rapid identification of contents, medical supply cabinets above the litter patient shall have shatter-proof, transparent or lightly tinted, sliding or flip-up doors.

1. Doors shall be provided with near flush grip, or low profile handles, not to exceed 1 inch of intrusion.
2. Storage compartments shall be divided into sections.
 - a. Drawers shall be marine style slide or tilt.
 - b. All shelves shall be removable.
3. Sliding doors for cabinets designed to carry lightweight items such as dressings, bandages, etc. shall be furnished.
 - a. Shall automatically latch or be fitted with friction holding devices when in a closed position.
4. Doors shall have positively locked latches that are bolted to the door and the doorframe structure and are designed to remain closed during transports.
5. All cabinets shall be firmly anchored (bolted or welded) to tapping plates of the body structure.
 - a. Use of sheet metal or wood screws is not acceptable.
6. Open shelves shall be surrounded by a lip of not less than 1/2" in height.
7. Storage for the main oxygen cylinder shall be accessible for replacement from an outside position.
8. The oxygen compartment shall be provided with at least a 9 sq. in. of open vent to dissipate/vent leaking oxygen to the outside of the ambulance.
9. The oxygen storage area shall be configured and used only for the main oxygen cylinder and associated plumbing.
10. All oxygen cylinder mounts shall provide a restraining device(s) conforming to the requirements of SAE J3043 (*Ambulance Equipment Mount Device or Systems*).

C.11.4 PATIENT COMPARTMENT SEATING

All seats in the patient compartment shall conform to all applicable FMVSS requirements and SAE J3026 (*Ambulance Patient Compartment Seating Integrity and Occupant Restraint*). The seats(s) shall be installed according to the seat manufacturer's directions.

All patient compartment seating shall have no less than a Type II belt (3-point restraint system) installed at each seating location and shall meet the requirements of SAE J3026 (*Ambulance Patient Compartment Seating Integrity and Occupant Restraint*).

To facilitate cleaning and disinfecting, all seats furnished and installed by the FSAM shall be cleanable to OSHA standards, and all exposed surfaces shall be free of vent devices that would permit the entrapment of biological contaminants. This shall comply with OSHA 29 CFR 1910.1030.



C.11.4.1 PATIENT COMPARTMENT SEATING

Commercially produced seats (OEM seating) will be padded and have the largest practical padded back and headrests. The upholstery shall be non-absorbent, washable and impervious to disinfectants. Seat(s) manufactured by the FSAM shall be padded and have the largest practical padded back and headrests. The seats shall not be less than 15" deep by 18" wide (per seating position), and the seat backs shall be a minimum of 18" wide. Padding material shall be rubber or polyester urethane foam of a medium to firm density, with a minimum finished thickness (padding and upholstery) of 2.5" for seat pads, and 2" for head and backrests. Seats shall have 40 oz. (minimum) reinforced vinyl upholstery. The upholstery shall be non-absorbent, washable and impervious to disinfectants. All seating and restraint systems shall be tested in accordance with the requirements specified in SAE J3026 (*Ambulance Patient Compartment Seating Integrity and Occupant Restraint*).

C.11.4.2 SEATING OVERHEAD CLEARANCE

All seating positions in the patient compartment shall be provided with a vertical overhead clearance measurement of 43" and shall conform to AMD Standard 025 (*Measuring Guidelines: Occupant Clearance Zones*).

C.11.5 SEAT SAFETY BELTS AND ANCHORAGES

All designated seating positions in the patient compartment shall be equipped with safety restraint systems appropriate for each type of seating configuration.

C.11.6 LITTER FASTENERS AND ANCHORAGES

A litter fastener assembly with quick release latch shall be furnished. The installed litter fastener device(s) for wheeled cots shall meet the performance requirements of SAE J3027 (*Ambulance Litter Integrity, Retention, and Patient Restraint*). The litter fastener shall be installed according to the litter fastener manufacturer's directions.

All cots and infant transporters should only be used with the required fastener assembly as prescribed by the cot/transporter manufacturer.

The litter attachment will be tested in accordance with AMD 004 (*Litter Retention System*).

C.11.7 IV HOLDER FOR INTRAVENOUS FLUID CONTAINERS

One IV mount specifically designed for holding IV containers shall be provided, including Velcro type straps to adequately secure an IV bag/bottle. The device shall not protrude more than 1", and shall be located adjacent to, or on the cabinetry near the head of the primary patient. Swing down IV hangers with rigid support arms shall not be specified or furnished.

C.12 OXYGEN, MAIN SUPPLY AND INSTALLATION AND SUCTION

The ambulance shall have a piped medical oxygen system capable of storing and supplying a quantity of medical oxygen appropriate for your service area. The installed medical oxygen piping shall be leak tested to 80 PSI. After the successful completion of piping test, the system shall be completely assembled and the flow rate of the outlets tested with the system pressurized at normal working pressure. The system shall be capped then tagged with date and signature of person and firm performing the tests. Each completed ambulance shall conform to AMD Standard 015 (*Ambulance Main Oxygen System Test*). All oxygen cylinder mounts shall provide a restraining device(s) conforming to the requirements of SAE J3043 (*Ambulance Equipment Mount Device or Systems*).

The main oxygen supply shall be from a compressed gas cylinder(s) the purchaser will provide and install at the time the vehicle is placed in service. A cylinder-changing wrench shall be furnished, chained and clipped within the oxygen cylinder compartment.

The cylinder controls shall be accessible from the inside the vehicle. A device shall be visible from the EMSP's seat that indicates cylinder pressure. The use of remote high-pressure lines and gauges are not allowed. The oxygen cylinder(s) shall be accessible for changing from the exterior of the body.

The purchaser shall specify the type of quick disconnect, to be used. The FSAM shall install all other components and accessories required for the piped oxygen system, which shall include as a minimum:

1. A pressure regulator.
2. Low pressure, electrically conductive, hose and fittings approved for medical oxygen.
3. Oxygen piping shall be concealed and not exposed to the elements, securely supported to prevent damage, and be readily accessible for inspection and replacement.
4. Oxygen shall be piped to a self-sealing duplex oxygen outlet station for the primary patient with a minimum flow rate of 100 LPM at the outlet.
5. Outlets shall be marked and identified and not interfere with the suction outlet.

C.12.1 OXYGEN PRESSURE REGULATOR

The medical, oxygen pressure reducing, and regulating valve with inlet filter at the cylinder shall have line relief valve set at 200 psi maximum, and a gauge or digital monitor with a minimum range of 0 to 2,500 psi with the gauge or display scale graduated in not more than 100 PSI increments. The regulator shall be easy to connect and preset, with a locking adjustment, at 50 +/- 5 psi line pressure.

With the regulator set at 50 +/- 5 psi, a 100 LPM minimum flow rate shall be available at all oxygen outlets.

This regulator shall perform as required at an inlet pressure range from 150 psi to 2500 psi.

C.12.2 SUCTION ASPIRATOR, PRIMARY PATIENT

An electrically powered suction aspirator system shall be furnished and shall conform to AMD Standard 021 (*Aspirator System Test, Primary Patient*). The vacuum control, vacuum indicator and collection bottle or bag shall be located so that the EMSP can properly operate the device from the EMSP seat. The electric type aspirator system shall be connected per Figure 3. The suction pump shall be located in an area that is accessible and vibration insulated from the patient compartment.

1. The pump shall be vented to the vehicle's exterior.
2. A vacuum control and a shut-off valve, or combination thereof, shall be provided to adjust vacuum levels.
3. A vacuum indicator gauge graduated at least every 100 mm Hg and a minimum total range of 0 to 760 mm Hg, shall be provided.
4. The collection bottle or bag shall be non-breakable and transparent with a minimum 1,000 ml capacity.
5. The minimum inside diameter for the suction tubing connectors shall be at least 1/4 in. The end user shall provide any suctioning catheters desired.
6. The suction aspirator system shall provide a minimum of 30 LPM flow at the catheter tip.

RECOMMENDED ENHANCEMENT – SUCTION MOUNT: If the device is 3 lb. or greater, including the weight of the volume of the container/contents, mount system should meet the requirements of SAE J3043 (*Ambulance Equipment Mount Device or Systems*).

C.13 ENVIRONMENTAL: CLIMATIC AND NOISE PARAMETERS

C.13.1 ENVIRONMENTAL SYSTEMS

All ambulances will be equipped with a complete heating, ventilating, and air conditioning system(s) (HVAC) to supply and maintain clean air conditions and specified level of inside temperature in both driver and patient compartments and shall conform to AMD Standard 012 (*Interior Climate Control Test*). The system(s) may be separate or a combination system, which will permit independent control of the environment within the driver's cab and patient compartment. All ambulances will be equipped with HVAC that can be made to collectively operate using re-circulated air and outside ambient air and will be capable of maintaining a patient compartment temperature of 68°F to 78°F while patients are in the patient compartment. The air systems will be high volume capacity with low velocity delivery for minimum draft circulation. Environmental system components will be readily accessible for servicing at the installed location(s). Connecting hoses for heating and the air conditioning system will be supported by rubber-insulated metal clamping devices at least every 18".

C.13.2 VENTILATION CRITERIA

Ventilation system(s) of the driver and patient compartments will provide a complete change of ambient air within both compartments with the vehicle stationary. Ventilation will be separately controlled within the cab and patient compartments. Fresh air intakes will be located towards the front of the vehicle and exhaust vents will be located on the upper rear of the vehicle. Exhaust vents may be located on the rear lower half of the module/body, provided the vent/device incorporates a reverse flow damper to prevent back draft and intrusion of vehicle engine exhaust, dust, dirt, or road spray. The patient compartment will be ventilated by the air delivery system of the environmental equipment (heater-air conditioner) or by separate system(s), such as power intake, exhaust ventilator(s).

C.13.3 ENVIRONMENTAL CONTROLS

Adjustable, manual or thermostatically operative controls will permit heating and/or air conditioning and ventilation in either compartment without affecting the other compartment. Switches and controls shall be accessible to the EMSP when seated and restrained. Blower or fan system will have at least three speeds (excluding "OFF"). Separate non-corroding brass, bronze, stainless steel, plastic or other inherently corrosion proof shutoff valves, for the patient compartment hot water heating system, will be provided. The use of vacuum or electrically operated shutoff valves is acceptable provided it will meet the above criteria and the valve provides inherent sealing when vacuum is removed. This sealing will prevent engine cooling system pressure and water pump pressure from causing any leakage when vacuum is removed. Air systems will have adjustable louvers to direct the flow of air.

RECOMMENDED ENHANCEMENT – ENVIRONMENTAL CONTROLS FOR MEDICATIONS: Precautions should be taken to minimize the effect of external conditions on the quality and stability of pre-hospital medications.



C.13.5 CAB AND PATIENT COMPARTMENT SOUND LEVEL CRITERIA

The ambulance patient compartment sound level shall not exceed 80 dB, as tested per AMD Standard 006 (*Patient Compartment Sound Level Test*) for an extended period of time. The sound level in the vehicle shall comply with OSHA requirements, 29 CFR 1910.95 (*Occupational Noise Exposure*).

C.14 COMMUNICATIONS

C.14.1 COMMUNICATION EQUIPMENT

If installed by the manufacturer, communications equipment will meet the applicable FCC (Federal Communications Commission) (47 CFR Part 90) rules and required state and local area EMS radio communication protocols.

C.14.2 RADIO (MOBILE) PROVISIONS

If installed by the manufacturer, all ambulances will be provided with sufficient ventilated space for a two-way radio (including convenience features), antenna openings, ground plane, terminal wiring for 12V power and ground.

C.14.3 ANTENNA CABLE AND ACCESS

The FSAM shall provide each ambulance with a ground plane, and coaxial lead-in wire from the ventilated radio storage area/compartment to the centerline of the patient compartment roof. An antenna wiring access/port shall be provided in the patient's compartment directly under the coaxial leads. The port shall provide a least a 16 sq. in. clear access. All nonmetallic roofs will be equipped with at least a 40" x 40" metal ground plane molded into the roof. The ground plane then shall be properly grounded to the chassis ground. The antenna cable (lead-in) shall be provided and clearly labeled with RG/58U or equal cable. Approximately 18" of extra cable shall be provided at the roof and approximately 36" at/in the radio area/compartment.

C.14.4 SIREN – PUBLIC ADDRESS

A combination electronic siren with integral public address system shall be provided. A "Horn/Siren" switch shall be provided on the driver's console. When "on" shall include a hands-free option to activate or change the siren tone when the horn button is pushed. Dual speakers shall be installed in the bumper/hood area, or similar surface mount. Speakers shall not protrude beyond the face of the bumper or bumper guards. The siren shall be capable of producing a continuous warning sound at a minimum level of 123 dB, A-weighted, at 10' and shall conform to AMD Standard 023 (*Siren Performance Test*).

C.15 ADDITIONAL SYSTEMS, EQUIPMENT, ACCESSORIES, AND SUPPLIES

C.15.1 STANDARD MANDATORY MISCELLANEOUS EQUIPMENT

Each ambulance shall be equipped with, but not limited to the following:

1. Fire extinguishers: Two, (ABC dry chemical or carbon dioxide) minimum 5 lb unit, with a quick release bracket. One shall be located in the driver's cab, the other in the patient compartment. This shall meet the requirements of SAE J3043 (*Ambulance Equipment Mount Device or Systems*).
2. "No Smoking Oxygen Equipped" and "Fasten Seat Belts" signs: Conspicuously placed in the driver's cab and patient compartment.
3. Backup alert alarm, (audible warning device) activated when the vehicle is shifted into reverse, which cannot be disabled or reset by the operator. Device shall be rated for 97 dB-a at 4' (per SAE standards).

**C.16 BODY PAINTING****C.16.1 PREPARATION FOR BODY PAINTING**

Ambulance body and all attached equipment exterior surfaces, except polished metal parts, shall be thoroughly cleaned, treated, and coated with a firm primer and preservative with rust inhibiting properties, and painted in the finish color as specified. Ferrous metal interior surfaces shall be painted or, when not exposed for painting, shall be treated or coated to resist corrosion. Chassis and chassis frame components shall be preserved and finished in accordance to industry's standard practice.

C.16.2 SALT SPRAY RESISTANCE

Treated exterior sheet metal of the ambulance body (except OEM Type II van) shall be capable of withstanding 250 hours of salt spray tested in accordance with ASTM B 117. The specimen used for the salt spray test shall be run through all steps of the cleaning and treating process, including priming. The primed specimen shall be scored from corner to corner using a sharp knife. After the test, the specimen panels shall exhibit no failure and not more than 1/8" rust or blister creepage from the scored lines.

C.17 MARKINGS, AND CAUTION AND IDENTIFICATION PLATES**C.17.1 CAAS GVS CERTIFICATION**

The FSAM's "CAAS GVS" certification shall be provided on a placard or label permanently affixed and easily visible.

C.17.2 CAUTION AND IDENTIFICATION PLATES

FSAM's caution plates and identification plates shall be conspicuously installed for all equipment, etc., furnished requiring such notices.

C.18 MANUALS AND HANDBOOK OF INSTRUCTION

The FSAM shall furnish with each ambulance one copy of a handbook of instruction in electronic media. This handbook shall contain all information and safety precautions to insure that the operator of the ambulance can properly operate and perform required operator level maintenance specific to the ambulance purchased. As a minimum, this handbook of instruction shall contain the following:

1. Copy of FSAM's invoice showing date of delivery and conditions of sale.
2. FSAM's "CAAS GVS" certification of compliance statement.
3. Copy of the FSAM's pre-delivery Inspection/test form signed by FSAM's inspector .
4. Copy of FSAM's final (as built) work order.
5. Shipping papers.
6. List of the FSAM's service points.
7. FSAM's components and equipment information (hardware, fixture, etc.) including part numbers specific to the ambulanced purchased.
8. Complete wiring diagrams and schematics for wiring added to the OEM chassis by the FSAM.
9. OEM's operator manual (may be in printed form, if electronic form is not available from OEM).
10. Equipment manufacturer's operator manual(s) for any equipment furnished with, or as a part of the ambulance (may be in printed form if electronic form is not available from OEM).
11. All warranty information.
12. Weight documents from a certified scale showing actual loading on the front axle, rear axle, and overall ambulance at curb weight.



13. Payload Calculation Form.
14. Certification of successful completion of the tests in AMD Standards 001, 005, 009, 010, 015, 021 & 025 by the FSAM for the ambulance listed in the FSAM's as built work order.
15. Certification for components meeting SAE J3026, SAE J3027, and SAE J3043.

C.19 WORKMANSHIP STANDARD

1. Vehicles shall be free from defects that may impair their serviceability or detract from appearance.
2. All bodies, systems, equipment, and interfaces with the chassis shall be done in accordance with the OEM Body Builders Book.
3. The vehicle will be built with attention to the following:
 - a. Rough, sharp, or unfinished edges, burrs, seams, corners, and joints.
 - b. Grit, seeds, orange peel, fish eyes, streaks, running, sagging, wrinkles, pin holes, craters in paint, failure to meet minimum thickness requirements and non uniformity of specified color.
 - c. Body panels or components that are uneven, unsealed, or contain cracks and dents.
 - d. Misalignment of body fasteners, glass, viewing panels, light housings, other items with large or uneven gaps, spacing, etc., such as door, body panels, and hinged panels.
 - e. Improperly fabricated and routed wiring or harness.
 - f. Improperly supported or secured hoses, wires, wiring harnesses, mechanical controls, etc.
 - g. Interference of chassis components, body parts, doors, etc.
 - h. Leaks of any gas, vacuum, or fluid lines (air conditioning, coolant, oil, etc.).
 - i. Noise, panel vibrations, etc.
 - j. Inappropriate or incorrect use of hardware, fasteners, components, or methods of construction.
 - k. Incomplete or improper welding, riveting, or bolting.
 - l. Lack of uniformity and symmetry where applicable.

SECTION D – CAAS GVS COMPLIANCE CERTIFICATION REQUIREMENTS

D.1 QUALIFYING PROVISIONS

The FSAM is obligated to certify to the purchaser that the ambulance bearing the “CAAS GVS v.1.0” label, its components, and equipment meet or exceed all the requirements and tests set forth in this standard. The certification and “CAAS GVS v.1.0” label, verify that the ambulance conforms to the version of this standard in effect on the date the ambulance was contracted for. Compliance for a “CAAS GVS v.1.0” label is defined as certification backed by confirmed verifications of inspections and tests. The verifications shall be in possession of the issuer and presented if and when challenged. For the benefit of purchaser procuring activity evaluation and review, prior to or with each proposed bid (solicitation), the FSAM shall provide and forward representative material of their “CAAS GVS v.1.0” ambulance(s). This material shall include: a letter certified by the FSAM, stating that the delivered ambulance(s) shall comply with paragraphs D.3 thru D.6 Failure to provide certification, at the time the vehicle is presented for inspection, will deem the vehicle unacceptable and shall constitute grounds for termination in accordance with the terms of the contract. Also included shall be: general CAAS GVS v.1.0 data, exterior and interior pictures, dimensional drawings/data, etc., and other information as requested.

D.2 DOCUMENTATION OF “CAAS GVS v.1.0” COMPLIANCE CERTIFICATION

The FSAM shall compile complete certified documentation of verifications for all the tests required under D.3 for each Type of ambulance intended to be marketed to the Emergency Medical Care industry as a “CAAS GVS v.1.0” ambulance.

D.3 CRITERIA OF CERTIFICATIONS

The initial testing and inspections required for certification shall be performed by:

1. A Nationally recognized testing laboratory, recognized by OSHA under Appendix A to 29 CFR 1910.7

Or

2. An ISO/IEC 17025 accredited laboratory by an accreditation body that is recognized by the National Cooperation for Laboratory Accreditation (NACLA) or is a signatory to the International Laboratory Accreditation Cooperation (ILAC) Mutual Recognition Arrangement (MRA). The scope of accreditation shall include AMD Standards 001, 004-018, 020-025, and SAE J3043, J3026, J3027.

The individual certifications will remain valid for 5 years as long as the type of ambulance tested remains in production. Design changes during the 5-year certification period must be tested at the time of production release.

Certifications that appear on the ambulance need not be re-submitted (i.e.; DOT, EPA, etc.). Certification(s) will be acceptable in lieu of actual verification test during inspections providing supporting verifying data complying with D.4 is on file for examination.

Certification from OEM and individual equipment manufacturers are acceptable providing they are not part of a system(s) or altered and in accordance with D.4.

Type certifications of individual components and equipment products are acceptable.



Current valid certifications for KKK-A-1822F Star-of-Life Ambulances will be recognized as valid GVS certifications through the remaining KKK-A-1822F certification period for each individual document. To fully meet this provision, any specific GVS requirements not recognized by a KKK-A-1822F certification must be brought into compliance and verified accordingly.

D.4 CERTIFICATION LETTER FORMAT

Certification letters submitted for the ambulance model, components, and equipment being certified shall contain the following information on FSAM's letterhead stationery in electronic format (PDF files):

1. To whom certifying.
2. Date.
3. Units or items.
4. FSAM and address.
5. Date product tested.
6. Model number and standard data.
7. Applicable standard references and test requirement.
8. Summary of the test report.
9. A certifying statement with official signature.

D.5 CERTIFICATION VERIFICATION DATA REPORTS

The testing facility for each certification shall supply supportive verification data and information on letterhead stationery in electronic format (PDF files):

1. For whom tested.
2. Report date.
3. Name of sample product or device.
4. FSAM's address.
5. Serial and model number(s).
6. Standard referral and amendment number(s), and test requirement(s).
7. Test facilities used and location.
8. Test equipment used.
9. Test procedure.
10. Test results.
11. Verifying test data.
12. Photographs.
13. Test conclusion(s).
14. Witness(es), and authorized signature.

D.6 TESTS

D.6.1 TEST CRITERIA

The ambulance shall be prepared for operation in accordance with OEM's recommendations, AMD Standards 001, 004-018, 020-025, and SAE J3043, J3026, J3027. The ambulance shall successfully complete all parts of the quality conformance inspection.

SECTION E – CHANGES AND AMENDMENTS

E.1 CHANGES AND AMENDMENTS

Requests for changes or additions to the CAAS GVS v.1.0 supported by adequate justification should be sent to the CAAS General Headquarters:

CAAS
1926 Waukegan Road, Suite 300
Glenview, Illinois 60025-1770

A response will be provided for all submissions within 60 days. When necessary, new and revised information (in the form of amendments) regarding this standard will be issued from time to time. Amendments should be retained until such time as the entire document is revised.

E.2 GENERAL INQUIRIES – REQUESTS FOR INTERPRETATION

Requests for interpretations of standards shall be submitted in writing to CAAS, using the established request for interpretation form(s). All requests for interpretations shall include the date of the request, name and contact information of the party requesting the interpretation as well as a description of the request for interpretation, the specific section of the standard to be interpreted, the requester's understanding of the section and any other questions or specific information relevant to the request.

Proposed interpretations will be prepared by CAAS utilizing individuals and resources with particular expertise on the subject in question. All proposed interpretations shall be prepared in writing and shall be submitted to CAAS for approval. Notification of approved interpretations will be sent in writing to the requester within 3 business days.

E.3 PROCESS FOR REVISION

Revisions will be made on a periodic maintenance basis. Periodic maintenance is defined as the maintenance of a standard by review of the entire document and action to revise or reaffirm it on a schedule not to exceed five years from date of issuance. Any proposed revision or change will be posted for public comment according to CAAS policy. Comments regarding any of the proposed changes to standards shall be submitted in writing to CAAS using the established comment form(s). All submissions shall include the date of the comment submission, name and contact information of the submitter, as well as a description of the comment/suggestion, the specific section of the standard in question, the requester's understanding of the section and any other questions or specific information relevant to the request.

All comments submitted will be reviewed by the CAAS GVS standards committee and may include individuals and resources with particular expertise on the subject in question. Changes or revisions proposed as a result of public comments and suggestions will be open for an additional public comment period before final approval and adoption.



APPENDIX 1 - FIGURES

FIGURE 1 - CERTIFICATION & PAYLOAD SIGNAGE

The label shall be mounted on the body (module) interior in a conspicuous location.

1. The label shown here is suggested format.
2. Deviations in dimensions are acceptable.
3. All text must be included.

CERTIFIED "CAAS GVS" AMBULANCE

Date of Manufacture: _____

Mfg By: _____

Address: _____

City: _____ State: _____ Zip: _____

This ambulance conforms to the CAAS-GVS-2015 Standard in effect on the date the ambulance was contracted for.

Exceptions taken? No _____ Yes _____

If exceptions are taken, they must be listed in the handbook of instructions and identified by Section Number.

Final Stage Ambulance Manufacturers ID Number: _____

VIN: _____

OEM Chassis Model, Year of Manufacture: _____

Vehicle Type: _____

NOTICE: THIS VEHICLE, AS MANUFACTURED, CONFORMS TO THE PAYLOAD REQUIREMENTS OF THE CAAS-GVS-v.1.0 STANDARD. USERS SHALL NOT LOAD VEHICLES ABOVE THE GVWR, GAWRs OR EXCEED THE TOTAL USABLE PAYLOAD LISTED BELOW.

TOTAL USABLE PAYLOAD: _____ lbs.

(TOTAL REMAINING WEIGHT CAPACITY OF OCCUPANTS AND CARGO USER MAY ADD)



FIGURE 2 - PAYLOAD CALCULATION FORM

The completed form shall be included in the handbook of instructions.

1. The form shown here is suggested format.
2. Deviations in dimensions are acceptable.
3. All text must be included.

CUSTOMER TOTAL USABLE PAYLOAD INFORMATION	
Final Stage Ambulance Manufacturer's Name:	
OEM Chassis Year, Make, Model:	
1) Ambulance Model, Type, Prod. #:	
2) OEM GAWR – Front:	_____ lbs
3) OEM GAWR – Rear:	_____ lbs
4) OEM GVWR:	_____ lbs
5) Minimum Payload Per KKK-A-1822:	_____ lbs
6) Curb Weight – AS BUILT – Front Axle:	_____ lbs
7) Curb Weight – AS BUILT – Rear Axle:	_____ lbs
8) Total Curb Weight – AS BUILT:	_____ lbs
9) CUSTOMER USABLE Total Payload AS BUILT (item 4 minus item 8):	_____ lbs
10) CUSTOMER USABLE Front Axle Payload AS BUILT (item 2 minus item 6):	_____ lbs
11) Total Weight of Permanently mounted Options Specified (only required if item 9 does not meet or exceed item 5):	_____ lbs
12) Payload of Basic CAAS GVS Vehicle (item 9 plus item 11) (only required if item 9 does not meet or exceed item 5):	_____ lbs

FIGURE 3 - 12-VOLT DC ELECTRICAL SYSTEM

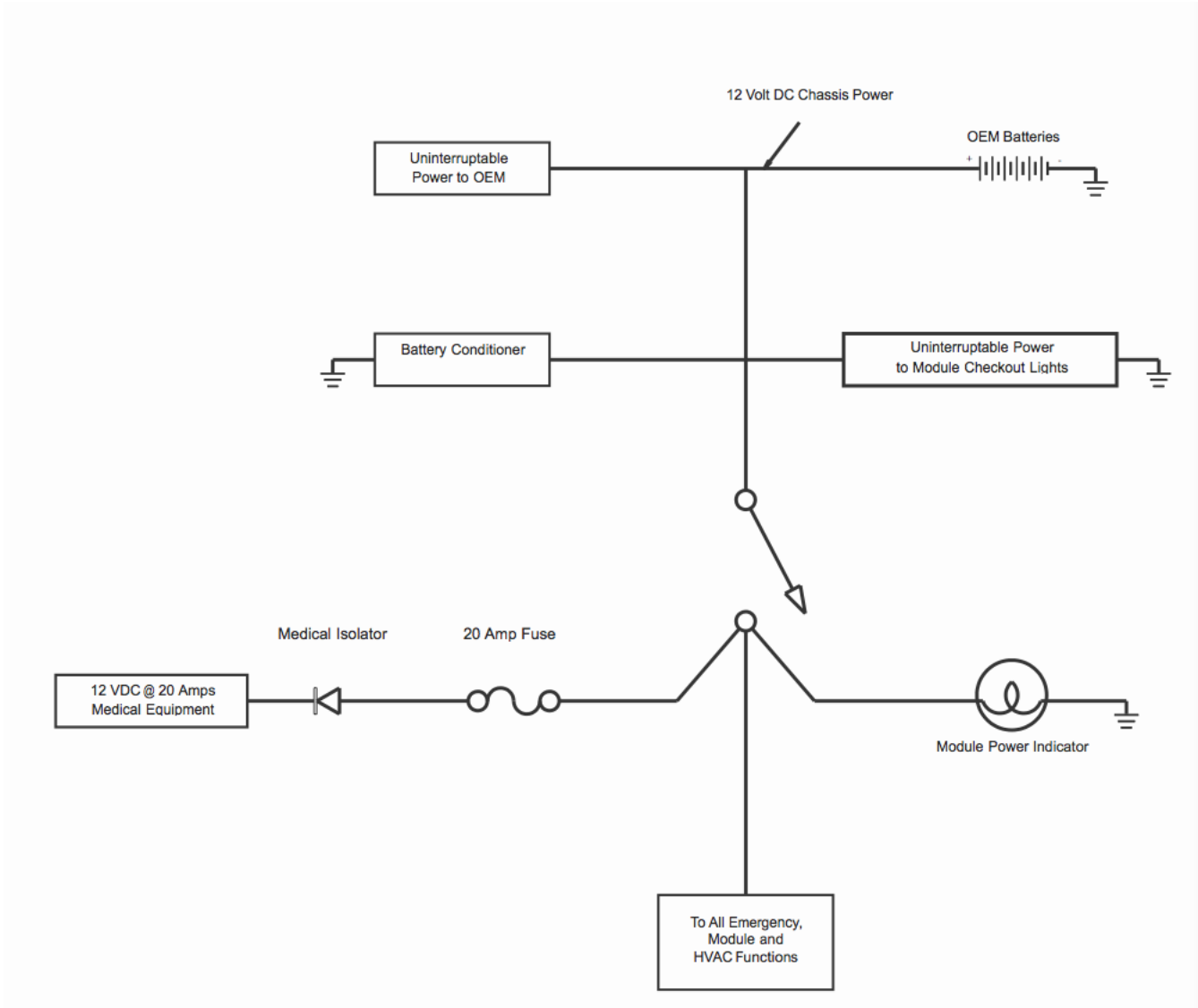

FIGURE 4 - 125-VOLT AC ELECTRICAL SYSTEM

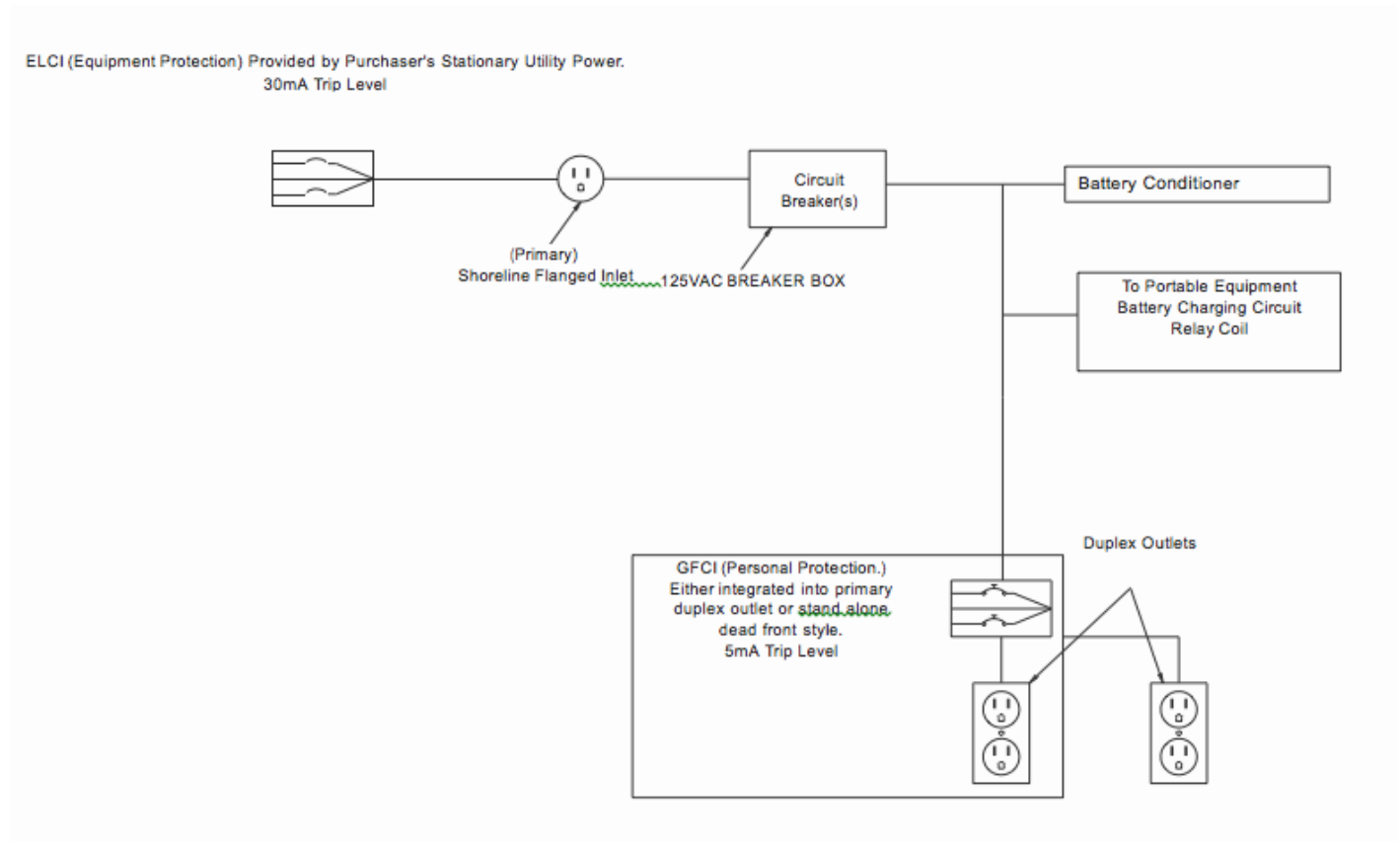
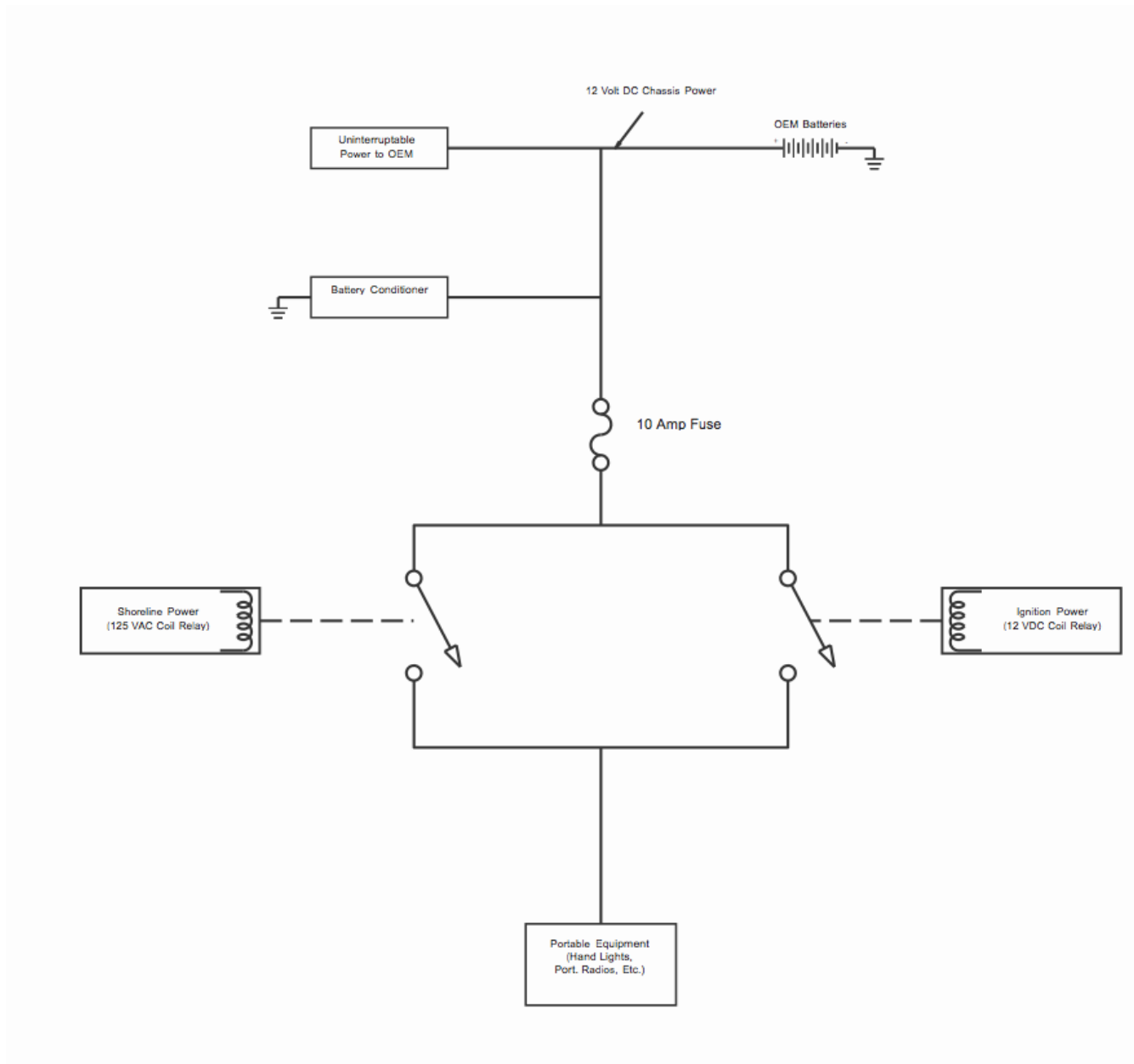

FIGURE 5 – PORTABLE EQUIPMENT BATTERY CHARGING CIRCUIT



APPENDIX 2 – BUYERS GUIDE

2.A QUALITY ASSURANCE PROVISIONS

2.A.1 RESPONSIBILITY FOR INSPECTION AND TESTS

The FSAM is responsible for the performance of all inspections and test requirements specified. The FSAM may use their own or any other facilities suitable for the pre-delivery and acceptance inspections unless disapproved by the purchaser. The purchaser reserves the right to perform any of the inspections and tests set forth in the standard where such inspections are deemed necessary to assure supplies and service conform to the standard and contract. The FSAM shall provide the purchaser's inspection representatives with the FSAM's readily available instruments and all such assistance as they may find necessary.

2.A.2 PURCHASER VERIFICATION

Quality assurance operations performed by the FSAM will be subject to purchaser verification at unscheduled intervals. Verification will consist of observation of the operations to determine that practices, methods, and procedures of the FSAM's inspection are being properly applied. Failure of the FSAM to promptly correct observed deficiencies shall be cause for suspension of acceptance of the ambulance(s) until conformance to standard criteria has been demonstrated.

2.A.2 INSPECTION FOR ACCEPTANCE

2.A.2.1 QUALITY CONFORMANCE INSPECTION

Quality conformance inspection applies to all ambulance(s) offered for acceptance under the contract. Quality conformance inspection shall consist of:

1. Workmanship inspection
2. Operational checks
3. Examination of the ambulance handbook
4. Verification of successful completion of AMD "finished vehicle" tests: 005, 009, 010, 015, 021.

2.A.2.2 OPERATION CHECKS

Operational checks of the ambulance shall cover all controls, electrical systems, and devices, doors, windows, cabinets, accessories, in and outside the ambulance. The ambulance shall be driven at highway speeds, turns made at minimum radii, brakes tested for dependability, and checked for rattles and squeaks. All controls and mechanisms shall function and operate as intended at the time of delivery.

2.A.2.3 INSPECTION FAILURE OF AMBULANCE(S)

Failure of a production ambulance to have the certifications required or successfully complete the examinations and tests shall be cause for non-acceptance of any of the contract quantity, until deficiencies are corrected and evidence of the corrective action preclude recurrence of similar deficiencies. Failure of the ambulance to successfully complete inspection shall not constitute an excusable delay in meeting scheduled deliveries.



2.A.3 WARRANTY

2.A.3.1 WARRANTY COVERAGE

The FSAM shall warrant the ambulance against parts failure or malfunction due to design, construction, or installation errors, defective workmanship, and missing or incorrect parts for a minimum period of 36 months or 36,000 miles (which ever occurs first).

The warranty begins when the purchaser accepts the ambulance from the FSAM FOB point of destination.

2.A.4 REPAIR PARTS AND SERVICE

As continuous operation of the ambulance described by this standard is of utmost importance for the successful FSAM to be in a position to render prompt service and to furnish replacement parts. Accordingly, FSAMs shall indicate the extent of their ability to render prompt service by furnishing a list of branch offices or agencies where complete stocks of repair parts are maintained and can be secured within a reasonable time after ordering by part number from the FSAM's part book and at such discount as may be quoted from year to year by the FSAM purchased under this standard.

2.A.5 STATEMENT OF ORIGIN OR BILL OF SALE

The manufacturer's Certificate of Origin or Bill of Sale for each vehicle procured shall be provided to the purchasing agency. The front of the document shall show the applicable RPN number shown on the Motor Vehicle Delivery Order. Non-OEM re-sellers must re-assign the document to the purchasing agency listed in the Consignee Mailing Address shown on the Motor Vehicle Delivery Order. The document shall be forwarded to the Consignee Mailing Address shown on the Motor Vehicle Delivery Order prior to shipment. Vehicle title/registration and safety/emission tests are the responsibility of the requisitioning agency.

2.B ADDITIONAL AND OPTIONAL EQUIPMENT

This standard provides the minimum technical requirements that new ambulances are required to meet. Some purchasers will require features in excess of these minimum requirements to complete their mission(s). The Buyer's Guide will assist purchasers in determining the optimum type, configuration and optional equipment required.

Purchasers may wish to consider some of the following criteria before completing the worksheet:

1. Operating environments such as inner city, rural areas, length of responses
2. Exposure to extreme ambient temperatures
3. Size of ambulance crew
4. State and/or local jurisdiction required medical equipment
5. State licensure requirements
6. Vehicle size and weight limitations in the response area
7. Expected service life of the ambulance
8. Additional non EMS equipment that must be carried on the ambulance
9. Future equipment requirements
10. Additional state or local requirements
11. Export requirements

In no event shall the specified or furnished optional item(s) reduce the quality and intent of the ambulance but shall enhance its design and purpose.



2.C CONFIGURATION WORKSHEET

This ambulance is to be a:

- BLS
- ALS
- Walkthrough
- Infrequent Transport

It is essential that the ambulance not be operated in an overloaded or unbalanced condition. The following information must be made available to properly design the interior and exterior compartmentalization of the ambulance. Attach:

1. A list of medical and rescue equipment to be supplied by the FSAM with the ambulance stating the item, quantity, where it is to be mounted or carried, the weight of each item, and its dimensions (L x W x H).
2. A list of medical and rescue equipment to be supplied by the purchaser to be carried on the ambulance stating the item, quantity, where it is to be mounted or carried, FSAM's responsibility for mounting, the weight of each item, and its dimensions (L x W x H) and the mount footprint or attachment or pattern.
3. A list of medical and rescue equipment that might be carried on the ambulance in the future stating the item, quantity, the desired mounting location or compartment where it is likely to be carried, the weight of each item, and its dimensions (L x W x H).
4. A list of permanently mounted equipment required on the ambulance showing the item, quantity, weight of each, and dimensions (L x W x H), who is to furnish the equipment as well as the location where it is to be carried.

1. Specify the maximum number of seated positions on the ambulance if more than five for modular bodies, or more than three for Type II units (*Standard seating is two in the cab, two on the side and one in the EMSP seat for modular bodies and two in the cab and one in the EMSP seat for Type II units*):

2. Describe the usage duty cycle that the ambulance will be subjected to:

3. If design approval drawings and/or a copy of the FSAM's work order are required to validate the design criteria in C.1, the type and quantity must be detailed here.

4. Careful consideration must be given to the ambient conditions the ambulance will operate in. Auxiliary heating and/or air conditioning may be required. If different than C.4, state the minimum and/or maximum operating temperatures in °F.

5. If different than C.4.3, state the required ride performance requirements:

6. If different than C.4.4, state the required min/max road speed required:



- 7. If different than C.4.6, state the required gradeability:

- 8. Per C.4.8, state the maximum overall length, width and height in inches:

- 9. If different than C.4.8.1, state the required angles:
- 10. Per C.5.2, the average weight of an occupant is calculated at 171 lbs. per NHTSA. If your average occupant weight is greater, specify here:

- 11. If a specific OEM's chassis is required in Section C.6, list the OEM here:

- 12. If all-wheel drive (AWD) or all-wheel drive conversion (AWDC) is required specify here. (It should be noted that AWD and AWDC will reduce the available payload and will increase the floor loading height. In some cases the floor loading height may be increased beyond the 34" maximum).

- 13. A diesel or gas engine is furnished as standard per C.6.3. If a specific engine type is required, specify here:

- 14. The OEM standard exhaust location and piping configuration is required per C.6.4.6. If an alternate location of type of piping termination is required, specify here:

- 15. An automatic transmission is furnished as standard per C.6.5.2. If a specific transmission type is required, specify here:

- 16. The OEM standard braking system is required per C.6.5.4. If an optional type braking system is required (air brakes, retarder, exhaust brake, etc.), specify here:

- 17. The OEM standard tires are furnished per Section 3.6.7. If an optional type tire is required, specify here. If a spare tire is required, specify mounting location here:



18. If automatic or manual tire chains are to be furnished to operate as required by C.6.8, specify here:

19. If different than C.6.11, specify the type of horn (air horn, etc.) required:

20. Specify any electrical loads beyond those defined in C.7.1 that are to be part of the minimum continuous electrical load. If a load management system is required, specify the sequence of control (shutdown). If functional enhancements (OEM or non OEM) are required to the high-idle system (interlock capabilities, automatic re-engagement, etc) specify here:

21. The OEM standard batteries are furnished per Section C.7.5. If an optional type battery is required, specify here. If a specific mounting location is required, specify here:

22. Specify any portable equipment charging provisions required in excess of those required by C.7.5.1:

23. If different than C.7.5.2, specify the number and type of power points required:

24. Specify any AC utility power requirements that are in excess of those required in C.7.6.1:

25. If an on board AC power system is required to operate with the system described in 3.7.6.3, the following must be specified:

Wattage of power source:

Voltage of power source:

Purity of power source:

(Allowable total harmonic distortion, voltage variation, power factor, frequency variation, etc)

Type of power source (shall be listed by a nationally recognized testing laboratory UL, CSA, etc):

- Portable Generator
- Hydraulically Driven Generator
- Direct Drive Generator
- Auxiliary Engine Driven Generator
- Belt Driven Generator or Alternator
- Derived From Ambulance Low Voltage Power Supply System (Inverter)
- Other:



Make, model, or other details of power source:

Panelboard location:

AC Powered Receptacle Information

Quantity	NEMA Conf	Location

AC Powered Lighting Information

Style/Make	Location	Wattage/Bulb	Type Mounting

An automatic transfer switch shall be furnished which turns off this onboard AC supply (inter- lock) and disconnects its output, when the AC utility power is applied. Transfer equipment, if not integral with the listed power source, shall be installed to ensure that the current carrying conductors from the on board 125-volt AC power source and from the 125-volt AC utility power source are not connected to ambulance electrical circuit at the same time. Generators shall comply with Article 445, "Generators," of NFPA 70, National Electrical Code.

The following shall be wired so that they can be energized only from the utility power, and not the onboard AC supply:

1. DC battery conditioner
2. Engine block heater

26. If different than C.7.6.1, specify the location for the utility power connector:



- 27. If known, specify the equipment that is to be powered by the receptacles specified in C.7.6.1:

- 28. If different than C.7.8, specify the location(s) for the patient compartment controls:

- 29. If a specific manufacturer's DOT lighting system is required in Section C.8.1, list the manufacturer here. State if a specific lighting system is required (such as all LED, etc.):

- 30. If a specific manufacturer's emergency lighting system is required in Section C.8.2, list the manufacturer and type (i.e.: strobe, LED, halogen) here. State if an alternate approved lighting system is required (such as NFPA 1901 compliant or SAE J2498 compliant). State if there are specific state or local jurisdiction requirements (such as California steady burning red, etc):

- 31. Specify any work lighting required beyond those defined in C.8.3:

- 32. Specify any interior lighting required beyond that defined in C.8.4 (map light, high intensity cot light, etc.):

- 33. The FSAM's standard cab console will be provided per C.9.1. If an optional type console is required (specific switch locations, specific size, etc.) specify here:

- 34. The OEM largest mirror system is required per C.9.5. If an optional type mirror system is required (power, heated, etc) specify here: _____
- 35. If different than 3.10.4, state the required increase to the patient compartment interior dimension(s): _____
- 36. A cab/patient compartment access window is required per C.10.2. On vehicles over 14,000 lbs. GVWR the opening may be expanded to permit a walk through opening in lieu of the window. If a walk through opening is required, specify the door type and size here:

- 37. An aluminum modular body is required per C.10.5. If an optional type body material is required specify here:



38. Hinged doors are required per C.10.8. If an optional type door system is required (sliding, etc) specify here:

39. If a specific manufacturer's latch, locking system, grab handle system, etc. is required in Section C.10.9, list the manufacturer and type here:

40. The floor is designed to carry a cot load of 400 pounds per C.10.10. If a heavier load is to be applied to the floor (Bariatrics, etc) specify here:

41. If a specific manufacturer's flooring is required in Section C.10.11, list the manufacturer and flooring type here:

48. Patient compartment seating is required per C.11.4. If an optional type seating is required (captain's chair, integral child safety seat, etc) specify here:

49. A cot fastener assembly is required per C.11.6. Specify the type of cot to be fastened by manufacturer and model number. If a cot is to be furnished by the FSAM, specify the manufacturer and model number of the cot to be furnished:

50. A medical oxygen system is required per C.12. Specify the type of outlets (DISS, NCG, Chemtron, Ohmeda, Puritan Bennett, etc) to be furnished. Specify the type and size of oxygen cylinder that will be furnished by the end user. If additional oxygen equipment is to be furnished by the FSAM, specify the manufacturer and model number to be furnished. If additional oxygen storage (more than 3000 liters) is required, specify here:

51. The patient compartment interior sound levels are not to exceed 80 dB per C.13.5. If lower sound levels are required specify here:

52. If electronic communication between the patient compartment and the cab (silent intercom, voice intercom, headsets integrated with the radio system, etc) are required specify here:



53. Provisions for mobile radio equipment are defined in C.14.2. Complete the following: Is the FSAM to provide the radio? Yes No
 Is the FSAM to install the radio? Yes No
 Make and model:
 Power requirements for radio:
 Mounting location for radio:
 Mounting location for control(s) and speaker(s):

54. Are there provisions required for computer equipment, drive camera, or other electronics?
 If so, list here:

55. If a specific manufacturer's siren and/or control system is required in Section C.14.4, list the manufacturer here:

56. Specify any additional backup assist systems required beyond those defined in C.15.2-4:

57. The ambulance will be painted and marked per C.16. State if an alternate approved painting and/or marking system is required (such as NFPA compliant and/or specific state or local jurisdiction requirements). A graphic design meeting the reflectivity requirements of C.16.4 shall be permitted to replace the required striping material if the design covers at least the same perimeter length and total area of coverage in sq. in. required by C.16:

58. Each ambulance comes with an instruction manual and handbook of construction per 3.18. These documents are designed to insure that the operator of the ambulance can properly operate and perform required operator level maintenance specific to the ambulance purchased. If additional operational instruction and/or maintenance instruction is required, those requirements should be detailed here. If actual service and parts manuals are required, those requirements should be detailed here. With a few exceptions, the manual and handbook of instruction will be in electronic form. If other media is required (all paper, etc.) specify here:

QUALITY ASSURANCE PROVISIONS

The type of inspection (source and/or destination) needs to be specified as well as where and when the acceptance inspection is to occur.

Section D details the minimum testing requirements for acceptance. If additional or alternative testing is required, specify here:



Section D.6 requires 3rd party testing. If an alternate form of 3rd party validation of the testing is required, specify here:

PREPARATION FOR DELIVERY

If a different mode of delivery or preparation for delivery than is specified in Section 5.0 the requirements should be detailed here along with the delivery address for the ambulance.

NOTES

If an extended warranty (beyond what is required in Appendix 2.A.3) on the entire vehicle or specific components is required, indicate which component(s) and the length and scope of the warranty:

TYPE II AMBULANCE

Type II ambulance – Long wheelbase Van with integral Cab Body.

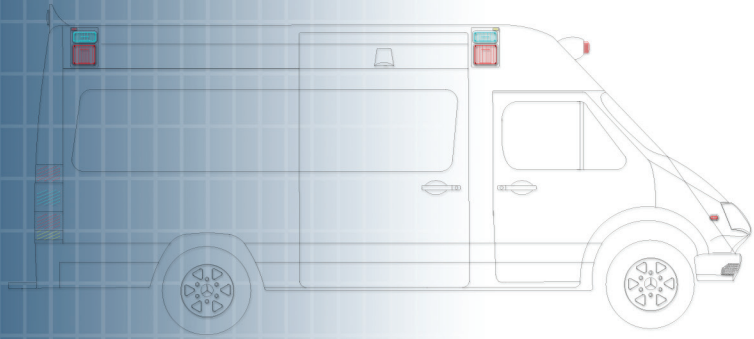

TYPE III AMBULANCE

Type III ambulance – Cutaway Van with integrated modular Ambulance Body.

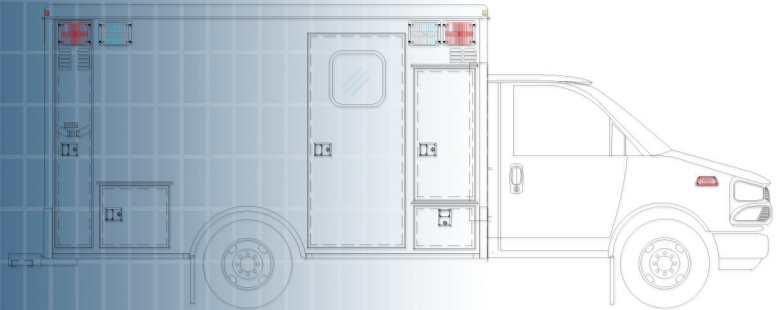

TYPE I AMBULANCE

Type I ambulance – Cab Chassis with a modular Ambulance Body.

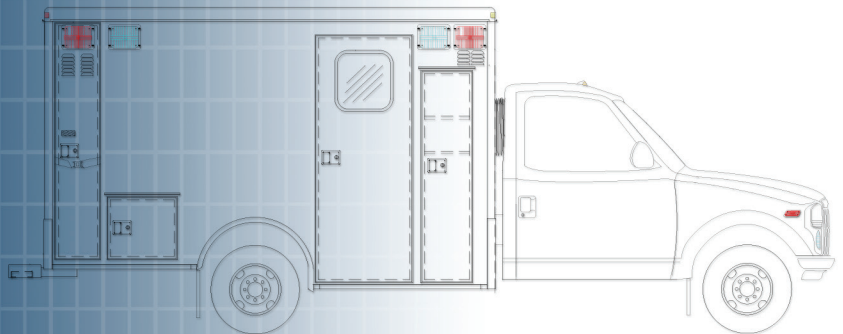

TYPE I-AD (MEDIUM DUTY) AMBULANCE

Type I-AD – Cab Chassis with modular Ambulance Body, increased GVWR, storage and payload.

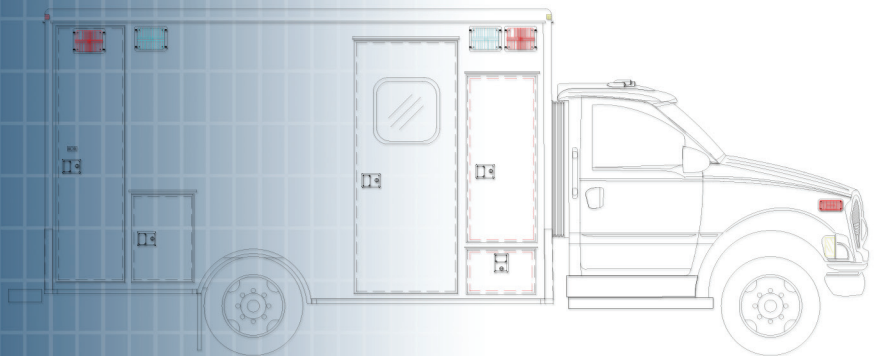

The Commission on Accreditation
of Ambulance Services

www.groundvehiclestandard.org

www.caas.org